

51002

Hexagonal socket wrench set

1/4"

ATORN®

Type

All tools are stored vibration-free.

Quality

Chrome-vanadium steel.

51002



Set contents	
○	13 Hexagonal inserts with energy profile AF 4 / 4.5 / 5 / 5.5 / 6 / 7 / 8 / 9 / 10 / 11 / 12 / 13 / 14 mm
	Each with 1 reversible ratchet, handle with sliding piece, universal joint
	2 Extensions 50 / 105 mm

Set contents	Type	51002	...
18-piece	in sheet steel case with foam-material inlay		101

51005

Hexagonal socket wrench set

1/4"



Quality

Chrome-vanadium steel.

51005



Set contents	
○	11 Hexagonal inserts AF 4 / 4.5 / 5 / 5.5 / 6 / 7 / 8 / 9 / 10 / 11 / 13 mm
	Each with 1 reversible ratchet 135 mm, handle with sliding piece 115 mm
	Each with 1 flex handle with hole for straight shaft 150 mm, straight shaft 115 mm
	2 Extensions 75 / 150 mm

Set contents	Type	51005	...
17-piece	in metal box		201

51008

Hexagonal socket wrench set

1/4"

GEDORE

Type

Impact-proof plastic case with PUR insert.

Quality

Vanadium 31CrV3.

51008



Set contents	
○	11 Hexagonal inserts AF 4 / 4.5 / 5 / 5.5 / 6 / 7 / 8 / 9 / 10 / 11 / 13 mm
	Each with 1 reversible ratchet, handle with sliding piece, driver with plastic grip, universal joint
	1 Extension 97 mm.

Set contents	Type	51008	...
16-piece	in plastic case		101

51009

Hexagonal socket wrench set

1/4"

STAHLWILLE®

Type

Chrome-plated.

Quality

Chrome alloy steel.

51009



Set contents	
○	13 Hexagonal inserts with AS-drive profile AF 3.5 / 4 / 4.5 / 5 / 5.5 / 6 / 7 / 8 / 9 / 10 / 11 / 12 / 13 mm
	Each with 1 reversible ratchet, handle with sliding piece, driver with plastic grip, universal joint
	2 Extension 54 / 150 mm

Set contents	Type	51009	...
19-piece	in sheet steel case		105



Socket Wrenches Sets

51021

Double hexagonal socket wrench set

1/4"



GEDORE

Quality
Vanadium 31CrV3.

51021



Set contents	
11	Double hexagonal inserts with UD profile AF 4 / 4.5 / 5 / 5.5 / 6 / 7 / 8 / 9 / 10 / 11 / 13 mm
1	Reversible ratchet
1	Handle with sliding piece
1	Multi-handle with non-slip 2-component handle and inner square according to DIN 3120-C6.3 (1/4 inch)
1	Universal joint
1	Extension 97 mm
1	Adapter 1/4 inch hexagonal head solid x 1/4 inch outer square solid

Set contents	Type	51021	...
17-piece	in plastic case		101

51022

TRIPLEplus socket wrench set

1/4"



ATORN

Type
Highly polished chrome-plated.

Use
Universal screw system for hexagonal, double hexagon and E-TX bolts and nuts.
Fits all standard imperial sizes.
Quality
Chrome-vanadium steel.

mm	hexagonal	double hexagonal	inch	E-TX
4.0	x	x	5/32	E 5
4.5	x	x	-	E 6
5.0	x	x	3/16	-
5.5	x	x	-	-
6.0	x	x	-	E 8
7.0	x	x	9/32	-
8.0	x	x	5/16	E 10
9.0	x	x	11/32	-
10.0	x	x	3/8	E 12
11.0	x	x	7/16	E 14
12.0	x	x	15/32	E 16
13.0	x	x	1/2	-
14.0	x	x	9/16	E 18

Set contents	
13	Inserts AF 4 / 4.5 / 5 / 5.5 / 6 / 7 / 8 / 9 / 10 / 11 / 12 / 13 / 14 mm (cat.-no. 51072)
7	Bits for TORX® screws T 10 / 15 / 20 / 25 / 27 / 30 / 40
2	Bits for Phillips recess head screws PZ 1 / 2
2	Bits for Phillips recess head screws PH 1 / 2
6	Bits for hexagon socket head screws AF 3 / 4 / 5 / 6 / 7 / 8 mm
5	Bits for XZN Trisquare socket head screws M 4 / 5 / 6 / 8 / 10
1	Reversible ratchet (cat.-no. 51127 101)
1	Driver with plastic grip
1	Extension 100 mm
1	Universal joint
1	Adapter 1/4 inch □ / 1/4 inch ○ (cat.-no. 52938 101)

Set contents	Type	51022	...
40-piece	in ABS plastic case		101

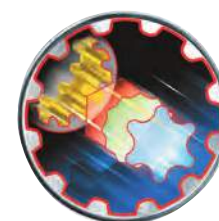

51022



When you think laterally ...



www.atorn.de

... new ideas arise.

ATORN

Performance requires quality

51023

Hexagonal socket wrench sets

1/4"

ATORN®

Type

All tools are stored vibration-free.

Quality

Chrome-vanadium steel.

Set contents 51023 101

○	12	Hexagonal inserts with energy profile AF 4 / 4.5 / 5 / 5.5 / 6 / 7 / 8 / 9 / 10 / 11 / 12 / 13 mm
●	5	Inserts for hexagon socket head screws AF 3 / 4 / 5 / 6 / 8 mm
+	2	Inserts for Phillips recess head screws PH 1 / 2
+	2	Inserts for Phillips recess head screws PZ 1 / 2
⊖	3	Inserts for slotted screws 0.8 x 4 / 1.0 x 5.5 / 1.2 x 6.5 mm
Each with 1 reversible ratchet, handle with sliding piece, universal joint		
	1	Extension 50 mm

Set contents 51023 102

○	13	Hexagonal inserts with energy profile AF 4 / 4.5 / 5 / 5.5 / 6 / 7 / 8 / 9 / 10 / 11 / 12 / 13 mm
○	4	Hexagonal inserts long type with energy profile, AF 8 / 10 / 11 / 13 mm
●	5	Inserts for hexagon socket head screws AF 8 / 10 / 11 / 13 mm
+	3	Inserts for Phillips recess head screws PH 1 / 2 / 3
+	3	Inserts for Phillips recess head screws PZ 1 / 2 / 3
⊖	3	Inserts for slotted screws 4 / 5.5 / 6.5 mm
★	6	Inserts for inner TORX® screws T 10 / 15 / 20 / 25 / 30 / 40
Each with 1 reversible ratchet, handle with sliding piece, universal joint		
	2	Extensions 50 / 105 mm

Set contents	Type	51023	...
28-piece	in sheet steel case with foam-material inlay	101	
42-piece	in sheet steel case with foam-material inlay	102	



51023 101



51023 102

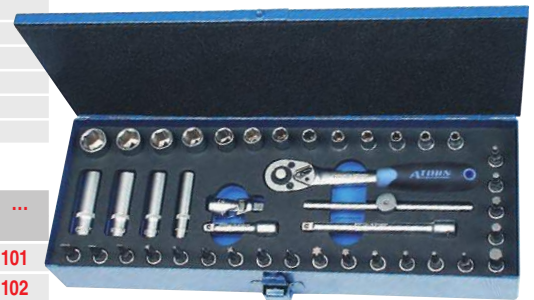

Hand Tools

51024

Hexagonal socket wrench set



Quality

Chrome-vanadium steel.

Set contents

○	12	Hexagonal inserts AF 4 / 4.5 / 5 / 5.5 / 6 / 7 / 8 / 9 / 10 / 11 / 12 / 13 mm
●	5	Inserts for hexagon socket head screws AF 3 / 4 / 5 / 6 / 8 mm
⊖	3	Inserts for slotted screws 4 / 5.5 / 7 mm
+	2	Inserts for Phillips recess head screws PH 1 / 2
+	2	Inserts for Phillips recess head screws PZ 1 / 2
	1	Reversible ratchet with ejection mechanism
	1	Driver with plastic grip
	1	Handle with sliding piece
	1	Universal joint
	1	Extension 50 mm

Set contents	Type	51024	...
29-piece	in plastic case	201	

51024



51025

Hexagonal socket wrench set



Quality

Chrome-vanadium steel.

Set contents

○	11	Hexagonal inserts AF 4 / 4.5 / 5 / 5.5 / 6 / 7 / 8 / 9 / 10 / 11 / 13 mm
●	6	Inserts for hexagon socket head screws AF 3 / 4 / 5 / 6 / 8 / 10 mm
⊖	3	Inserts for slotted screws 4 / 4.5 / 5 mm
+	4	Inserts for Phillips recess head screws PH 1 / 2 / 3 / 4
	3	Allen keys for hexagon socket head screws AF 1.5 / 2 / 2.5 mm
	1	Reversible ratchet
	1	Handle with sliding piece
	1	Driver with plastic grip
	1	Universal joint
	2	Extensions 50 / 100 mm
	1	Quick turning wheel

Set contents	Type	51025	...
34-piece	in plastic case	301	

51025



Socket Wrenches Sets

51026

Hexagonal socket wrench set



FACOM

Quality
Chrome-vanadium steel.

51026



Set contents	
9	Inserts OGV® profile AF 5.5 / 6 / 7 / 8 / 9 / 10 / 11 / 12 / 13 mm
6	Bits for TORX® screws T 10 / 15 / 20 / 25 / 30 / 40
3	Bits for Phillips recess head screws PH 1 / 2 / 3
1	Reversible ratchet
1	Driver with plastic handle
1	Extension 100 mm
1	Connecting piece 1/4 inch □ x 1/4 inch ○

Set contents	Type	51026	...
22-piece	in plastic case		101

51029

Hexagonal socket wrench set



BAHCO

Quality
Chrome-vanadium.

51029

Type
Matt chrome-plated. Plastic case made of impact-proof, oil and heat-resistant polyethylene (HDPE), 35 x 165 x 85 mm.



Set contents	
12	Hexagonal inserts AF 4 / 4.5 / 5 / 5.5 / 6 / 7 / 8 / 9 / 10 / 11 / 12 / 13 mm
2	Inserts for hexagon socket head screws AF 5 / 6 mm
2	Inserts for Phillips recess head screws PH 2 / 2
6	Inserts for TORX® screws T 10 / 15 / 20 / 25 / 30 / 40
1	Reversible ratchet
1	Swivelling extension 100 mm
1	Bit holder with action spring 1/4 inch mount

Set contents	Type	51029	...
25-piece	in plastic case		101

51034

Hexagonal socket wrench set



GEDORE

Quality
Vanadium 31CrV3.

51034

Type
With forged, tempered hexagonal socket wrench inserts and accessories.



Set contents	
11	Hexagonal inserts AF 4 / 5 / 6 / 7 / 8 / 9 / 10 / 11 / 12 / 13 / 14 mm
5	Inserts for hexagon socket head screws AF 3 / 4 / 5 / 6 / 8 mm
4	Inserts for slotted screws 0.8 x 4 / 1.0 x 5.5 / 1.2 x 6.5 / 1.6 x 8 mm
3	Inserts for Phillips recess head screws PH 1 / 2 / 3
3	Inserts for Phillips recess head screws PZ 1 / 2 / 3
1	Reversible ratchet finely toothed
1	Handle with sliding piece
1	Driver with plastic grip
1	Universal joint
2	Extensions 55 / 148 mm

Set contents	Type	51034	...
32-piece	in plastic case		201

When you think laterally ...



www.atorn.de

... new ideas arise.

ATORN®

Performance requires quality

51038

Hexagonal socket wrench sets

1/4"



Type
Chrome-plated.

Quality
Chrome alloy steel.



51038 101



Set contents 51038 101	
○ 13	Hexagonal inserts with AS-drive profile AF 3.5 / 4 / 4.5 / 5 / 5.5 / 6 / 7 / 8 / 9 / 10 / 11 / 12 / 13 mm
● 4	Inserts for hexagon socket head screws AF 3 / 4 / 5 / 6 mm
1	Reversible ratchet
1	Driver with plastic grip
1	Handle with sliding piece
1	Extension 150 mm
1	Universal joint

Set contents 51038 104	
○ 11	Hexagonal inserts with AS-drive profile AF 5 / 5.5 / 6 / 7 / 8 / 9 / 10 / 11 / 12 / 13 / 14 mm
● 5	Inserts for hexagon socket head screws AF 3 / 4 / 5 / 6 / 8 mm
⊖	3 Inserts for slotted screws 0.6x3.5 / 1.0x5.5 / 1.2x8.0 mm
⊕	4 Inserts for Phillips recess head screws PH 1 / 2 / 3 / 4
1	Reversible ratchet
1	Driver with plastic grip
1	Handle with sliding piece
2	Extensions 54 / 150 mm
1	Universal joint



51038 104



Set contents 51038 107	
○ 10	Hexagonal inserts with AS-drive profile AF 5 / 5.5 / 6 / 7 / 8 / 9 / 10 / 11 / 12 / 13 mm
● 5	Inserts for hexagon socket head screws AF 3 / 4 / 5 / 6 / 8 mm
⊛	9 Inserts for inner TORX® screws T8 / 9 / 10 / 15 / 20 / 25 / 27 / 30 / 40
⊛	6 Inserts for outer TORX® screws E4 / 5 / 6 / 7 / 8 / 10
1	Reversible ratchet
1	Driver with plastic grip
1	Handle with sliding piece
2	Extensions 54 / 150 mm
1	Universal joint



51038 107



Set contents	Type	51038	...
22-piece	in sheet steel case	101	
29-piece	in sheet steel case	104	
36-piece	in sheet steel case	107	

51032

Hexagonal socket wrench sets

1/4"



Type
With QuickRelease system
(one-hand safety lock).

Set contents 51032 101	
○ 13	Hexagonal inserts with AS-drive profile AF 3.5 / 4 / 4.5 / 5 / 5.5 / 6 / 7 / 8 / 9 / 10 / 11 / 12 / 13 mm
● 4	Inserts for hexagon socket head screws AF 3 / 4 / 5 / 6 mm
1	Reversible ratchet
1	Extension 150 mm
1	Universal joint
1	Driver
1	Handle with sliding piece



51032 101



Set contents 51032 201	
○ 12	Hexagonal inserts with AS-drive profile AF 4 / 5 / 5.5 / 6 / 7 / 8 / 9 / 10 / 11 / 12 / 13 / 14 mm
● 5	Inserts for hexagon socket head screws AF 3 / 4 / 5 / 6 / 8 mm
⊖	3 Inserts for slotted screws 0.6 x 3.5 / 1.0 x 5.5 / 1.2 x 8 mm
⊕	2 Inserts for Phillips recess head screws PH 1 / 2
⊕	2 Inserts for Phillips recess head screws PZ 1 / 2
1	Reversible ratchet
2	Extensions 54 / 150 mm
1	Universal joint
1	Driver
1	Handle with sliding piece



51032 201



Set contents	Type	51032	...
22-piece	in plastic case	101	
30-piece	in plastic case	201	

Socket Wrenches Sets

51039

Hexagonal and Double hexagonal socket wrench set

1/4"

3/8"



Type
Chrome-plated.

Quality
Chrome alloy steel.

51039



Set contents

- 1/4" ○ 8 Hexagonal inserts with AS-drive profile AF 4 / 4.5 / 5 / 5.5 / 6 / 7 / 8 / 9 mm
- 5 Bits for hexagon socket head screws AF 3 / 4 / 5 / 6 / 8 mm
- ⊖ 6 Bits for slotted screws 0.5x3 / 0.6x3.5 / 0.8x4 / 1x5.5 / 1.2x6.5 / 1.6x8 mm
- ⊕ 3 Bits for Phillips recess head screws PH 1 / 2 / 3
- ⊕ 1 Bit for Phillips recess head screws PZ 2
- 1 Reversible ratchet
- 1 Driver with plastic grip
- 1 Extension 150 mm
- 1 Universal joint
- 1 Bit holder with hexagonal socket 1/4 inch
- 3/8" ○ 12 Double hexagonal inserts with AS-drive profile AF 10 / 11 / 12 / 13 / 14 / 15 / 16 / 17 / 18 / 19 / 21 / 22 mm
- 1 Hexagonal insert with AS-drive profile AF 16 mm-5/8 inch with rubber insert for spark plugs
- 1 Reversible ratchet
- 1 Handle with sliding piece
- 2 Extensions 76 / 240 mm
- 1 Universal joint
- 1 Adapter 3/8 inch □ x 1/4 inch ■
- 1 Bit holder with hexagonal socket 5/16 inch

Set contents	Type	51039	...
48-piece	in sheet steel case	201	

51045

Hexagonal socket wrench set HINOX

1/4"



Type
All tools are stored vibration-free.
Up to 20% higher torque values in the range of HINOX tools (static load). Stainless steel for higher strength at same hardness when compared to standard material (31 CrV 3). More safety, lower risk of injury. Up to three times longer tool life (shown in dynamic permanent-load comparison).

Environmentally friendly production without surface coating. No allergic reactions thanks to chemical coating.
Considerably longer tool life if compared to competitors' products (stainless steel instead of coating).
Weather-resistant application outdoors.
Quality
Stainless steel.

51045



Set contents

- Ⓢ 13 Hexagonal inserts with traction profile AF 4 / 4.5 / 5 / 5.5 / 6 / 7 / 8 / 9 / 10 / 11 / 12 / 13 / 14 mm
- 5 Inserts for hexagon socket head screws AF 3 / 4 / 5 / 6 / 8 mm
- 1 Reversible ratchet
- 1 Handle with sliding piece
- 1 Driver
- 1 Universal joint
- 2 Extensions 55 / 147 mm

Set contents	Type	51045	...
24-piece	in SmartCase with PUR soft foam-material inlay	101	

51040

Hexagonal socket wrench set

1/4"



Quality
Chrome-vanadium steel.

Set contents

- Ⓢ 12 Hexagonal inserts with traction profile AF 4 / 5 / 5.5 / 6 / 7 / 8 / 9 / 10 / 11 / 12 / 13 / 14 mm
- 5 Inserts for hexagon socket head screws AF 3 / 4 / 5 / 6 / 8 mm
- ⊖ 3 Inserts for slotted screws 0.6x3.5 / 1.0x5.5 / 1.2x8.0 mm
- ⊕ 2 Inserts for Phillips recess head screws PH 1 / 2
- ⊕ 2 Inserts for Phillips recess head screws PZ 1 / 2
- 1 Reversible ratchet
- 1 Handle with sliding piece
- 1 Driver with plastic grip
- 1 Universal joint
- 2 Extensions 55 / 147 mm

Set contents	Type	51040	...
30-piece	in SmartCase	201	



51040

51041

Hexagonal socket wrench set

1/4"



Quality
Chrome-vanadium steel.
CVD TiN-coated screwdriver bits.

Type

In SmartCase 185 x 153 x 52 mm. In safety insert system, 2-component soft foam-material inlay. All tools are stored vibration-free.

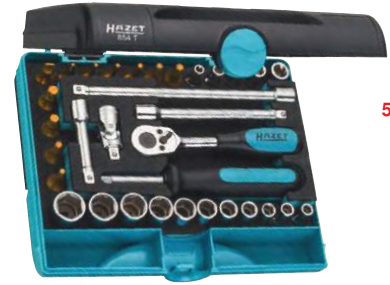

51041

Set contents	
11	Hexagonal inserts with traction profile AF 5 / 5.5 / 6 / 7 / 8 / 9 / 10 / 11 / 12 / 13 / 14 mm
5	Inserts for outer TORX® screws E 5 / 6 / 7 / 8 / 10
4	Inserts for hexagon socket head screws AF 3 / 4 / 5 / 6 mm
5	Inserts for inner TORX® screws T 10 / 15 / 20 / 25 / 30
1	Insert for slotted screws 1.0x5.5 mm
1	Insert for Phillips recess head screws PH 2
Each with 1 reversible ratchet, driver, universal joint	
3	Extensions 55 / 101.5 (swivelling) / 147 mm

Set contents	Type	51041	...
33-piece	in SmartCase	101	

51042

Hexagonal socket wrench set

1/4"



Quality
Chrome-vanadium steel.



51042

Set contents	
11	Hexagonal inserts with traction profile AF 5 / 5.5 / 6 / 7 / 8 / 9 / 10 / 11 / 12 / 13 / 14 mm
7	Bits for hexagon socket head screws AF 2 / 2.5 / 3 / 4 / 5 / 6 / 8 mm
4	Bits for slotted screws 0.5x4 / 0.6x4.5 / 0.8x5.5 / 1.2x6.5 mm
2	Bits for Phillips recess head screws PH 1 / 2
2	Bits for Phillips recess head screws PZ 1 / 2
6	Bits for ResistORX® with bore T 10 / 15 / 20 / 25 / 30 / 40
1 Bit reversible ratchet	
1	Adapter 25 mm 1/4 inch x 1/4 inch
1	Adapter 50 mm 1/4 inch x 1/4 inch
1	Adapter 75 mm 1/4 inch x 1/4 inch

Set contents	Type	51042	...
36-piece	in SmartCase	101	

51035

Hexagonal socket wrench set

1/4"



Quality
Chrome-vanadium steel.

Type

In SmartCase 185 x 153 x 52 mm. In safety insert system, 2-component soft foam-material inlay. All tools are stored vibration-free.



51035

Set contents	
10	Hexagonal inserts with traction profile AF 5.5 / 6 / 7 / 8 / 9 / 10 / 11 / 12 / 13 / 14 mm
5	Bits for hexagon socket head screws AF 3 / 4 / 5 / 6 / 7 mm
3	Bits for slotted screws 0.6x4.5 / 1.2x6.5 / 1.2x8 mm
3	Bits for Phillips recess head screws PH 1 / 2 / 3
3	Bits for Phillips recess head screws PZ 1 / 2 / 3
7	Bits for ResistORX® with bore T 10 / 15 / 20 / 25 / 27 / 30 / 40
1 Reversible ratchet	
1 Driver	
1	Adapter 1/4 inch x 1/4 inch
2	Extensions 55 / 101.5 mm

Set contents	Type	51035	...
36-piece	in SmartCase	101	

51036

Hexagonal socket wrench set

1/4"



Quality
Chrome-vanadium steel.

Type

- New ergonomic design
- Comfortable handling thanks to handy accessories



51036

Set contents	
10	Hexagonal inserts with traction profile AF 5.5 x 6 / 7 / 8 / 9 / 10 / 11 / 12 / 13 / 14 mm
5	Bits for hexagon socket head screws AF 3 / 4 / 5 / 6 / 7 mm
3	Bits for slotted screws 0.6x4.5 / 1.2x6.5 / 1.2x8 mm
3	Bits for Phillips recess head screws PH 1 / 2 / 3
3	Bits for Phillips recess head screws PZ 1 / 2 / 3
7	Bits for ResistORX® with bore T 10 / 15 / 20 / 25 / 27 / 30 / 40
Each with 1 Reversible ratchet, driver, universal joint	
2 Extensions 55 mm / 101.5 mm	
2 Adapter 1/4 inch x 1/4 inch and 1/4 inch x 1/4 inch	

Set contents	Type	51036	...
38-piece	in SmartCase (52 x 98 x 180 mm)	101	



Socket Wrenches Sets

51043

Hexagonal socket wrench set



Quality
Chrome-vanadium steel.

51043

Type

In plastic box with two-colour foam-material inlay.
The tools are held safely by the foam-material inlay.
Nothing will be lost.



Set contents	
10	Hexagonal inserts AF 5.5 / 6 / 7 / 8 / 9 / 10 / 11 / 12 / 13 / 14 mm
1	Reversible ratchet
2	Extensions 55 / 100 mm
1	Driver
1	Universal joint
1	Adapter 1/4 inch square drive x 1/4 inch hexagonal socket
5	Bits for hexagon socket head screws AF 3 / 4 / 5 / 6 / 7 mm
3	Bits for slotted screws 4.5 / 6.5 / 8.0 mm
3	Bits for Phillips recess head screws PH 1 / 2 / 3
3	Bits for Phillips recess head screws PZ 1 / 2 / 3
7	Bits for ResistORX® with bore T 10 / 15 / 20 / 25 / 27 / 30 / 40

Set contents	Type	51043	...
37-piece	in plastic case	201	

51051

Hexagonal socket wrench set



Type

With lever reversible ratchet, finely toothed (72 teeth), with 2-component handle.

51051



Set contents	
1	Lever reversible ratchet
12	Hexagonal inserts AF 4 / 4.5 / 5 / 5.5 / 6 / 7 / 8 / 9 / 10 / 11 / 12 / 13 mm
6	Inserts for hexagon socket head screws AF 3 / 4 / 5 / 6 / 8 / 10 mm
3	Inserts for slotted screws 4 / 5.5 / 6.5 mm
4	Inserts for Phillips recess head screws PH 0 / 1 / 2 / 3
2	Extensions 50 / 100 mm
1	Universal joint
1	Handle with sliding piece
1	Machine adapter 1/4 inch ■ x 1/4 inch ● Length 50 mm
1	Minimus change handle

Set contents	Type	51051	...
32-piece	in all-steel box	201	

51050

Hexagonal socket wrench set



Type

With reversible ratchet, finely toothed (72 teeth) with ring handrail.
Sliding guide in inner ring (1) and reverse function on outer ring (2).

51050

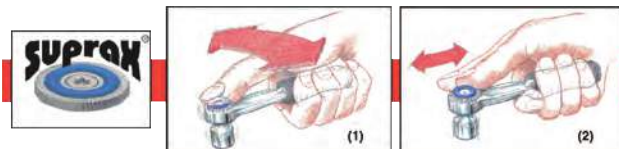

Set contents	
1	Reversible ratchet
12	Hexagonal inserts AF 4 / 4.5 / 5 / 5.5 / 6 / 7 / 8 / 9 / 10 / 11 / 12 / 13 mm
7	Inserts TORX® with bore T 10 / 15 / 20 / 25 / 27 / 30 / 40
6	Inserts for hexagon socket head screws AF 3 / 4 / 5 / 6 / 8 / 10 mm
1	Handle with sliding piece
1	Universal joint
2	Extensions 50 / 100 mm
1	Machine adapter 1/4 inch ■ x 1/4 inch ● Length 50 mm
1	Minimus change handle

Set contents	Type	51050	...
32-piece	in all-steel box	101	

Hand Tools

51052

Hexagonal socket wrench set

**carolus**

Type

With lever reversible ratchet, flexible,
7 steps with flex-stop variomatic.

51052



Set contents	
1	Lever reversible ratchet
12	Hexagonal inserts AF 4 / 4.5 / 5 / 5.5 / 6 / 7 / 8 / 9 / 10 / 11 / 12 / 13 mm
7	Inserts TORX® with bore T 10 / 15 / 20 / 25 / 27 / 30 / 40
1	Insert for slotted screws 5.5 mm
1	Insert for Phillips recess head screws PH 2
1	Insert for Phillips recess head screws PZ 2
3	Inserts for hexagon socket head screws AF 4 / 5 / 6 mm
1	Universal joint
1	Magnetic pick-up
2	Extensions 50 / 100 mm
1	Minimus pipe for double blade
1	Minimus double blade for slotted screws 2.5 / 3.5 mm
1	Minimus double blade for Phillips recess head screws PH 0 / 1
1	Bit coupling 1/4 inch with magnet slot
1	Machine adapter 1/4 inch ■ x 1/4 inch ● Length 50 mm
1	Minimus change handle

Set contents	Type	51052	...
36-piece	in all-steel box		401

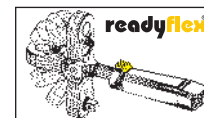

51046

Hexagonal socket wrench set

**carolus**

Type

With Readyflex® Freiraumknarre®, ring switching,
finely toothed (72 teeth).

51046



Set contents	
1	Readyflex® Freiraumknarre®
12	Hexagonal inserts AF 4 / 4.5 / 5 / 5.5 / 6 / 7 / 8 / 9 / 10 / 11 / 12 / 13 mm
6	Inserts for hexagon socket head screws AF 3 / 4 / 5 / 6 / 8 / 10 mm
3	Inserts for slotted screws 4 / 5.5 / 6.5 mm
4	Inserts for Phillips recess head screws PH 0 / 1 / 2 / 3
2	Extensions 50 / 100 mm
1	Universal joint
1	Handle with sliding piece
1	Machine adapter 1/4 inch ■ x 1/4 inch ● Length 50 mm
1	Minimus change handle
1	Bit coupling 1/4 inch with magnet slot

Set contents	Type	51046	...
33-piece	in all-steel box		301



51053

Hexagonal socket wrench set

**carolus**

Type

With Readyflex® Freiraumknarre®, ring switching,
finely toothed (72 teeth).

51053



Set contents	
1	Readyflex® Freiraumknarre®
12	Hexagonal inserts AF 4 / 4.5 / 5 / 5.5 / 6 / 7 / 8 / 9 / 10 / 11 / 12 / 13 mm
7	Inserts TORX® with bore TX 10 / 15 / 20 / 25 / 27 / 30 / 40
6	Inserts for hexagon socket head screws AF 3 / 4 / 5 / 6 / 8 / 10 mm
2	Extensions 50 / 100 mm
1	Universal joint
1	Handle with sliding piece
1	Machine adapter 1/4 inch ■ x 1/4 inch ● Length 50 mm
1	Minimus change handle
1	Bit coupling 1/4 inch with magnet slot

Set contents	Type	51053	...
33-piece	in all-steel box		401



Bit rails | Socket wrench inserts

51056

Bit rails, magnetic (empty)

1/4"



51056



Type

Outer square suitable for size 13 socket wrench inserts nominal size 6.3 (1/4 inch). **2 additional inner square wrench adapters for ratchets, sliding handles, extension pieces, etc.** A strong magnet allows for a secure fastening of the rail to metal objects. Additional boreholes allow the fastening to non-metallic objects and walls.



The bits are held securely by the ball by means of turning them 90°.

Turning them 90° in the opposite direction will release the bits so that they can be removed.

Tools not included.

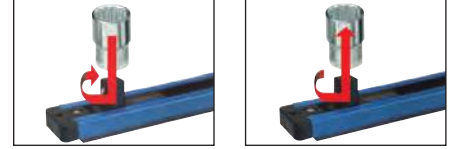

for inserts pcs.	Length mm	Width mm	Weight g	51056	...
13	380	33	350		101

Hand Tools

51059 - 51063

Hexagonal socket wrench inserts DIN 3124/ISO 2725

1/4"

Type

Chrome-plated, drop-forged.

Quality

Chrome-vanadium steel.

51059



With Energy profile.

51061



51062



With AS-drive profile.

Quality

HPQ heavy-duty steel.

51063



With tractions profile.

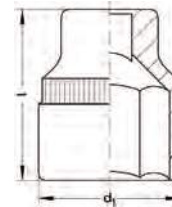

51059



51061



51062



51063



51063 L



AF mm	l approx. mm	d ₁ approx. mm	ATORN®		GEDORE		STAHLWILLE		HAZET	
			51059	...	51061	...	51062	...	51063	...
3.5	25	6.0					#	102		
4	25	6.8		103		103		103		403
L 4	50	6.7		104						
4.5	25	7.2		105		105		105		405
L 4.5	50	7.0	#	106	#	106				
5	25	8.1		107		107		107		407
L 5	50	7.9		108						
5.5	25	8.6		109		109		109		409
L 5.5	50	8.5		110						
6	25	9.2		111		111		111		411
L 6	50	9.2		112					#	412
7	25	10.8		113		113		113		413
L 7	50	11.0		114		114		114		414
8	25	11.7		115		115		115		415
L 8	50	12.0		116		116		116		416
9	25	13.0		117		117		117		417
L 9	50	13.0		118					#	418
10	25	14.3		119		119		119		419
L 10	50	14.5		120		120		120		420
11	25	15.8		121		121		121		421
L 11	50	15.5		122	#	122				422
12	25	17.0		123		123		123		423
L 12	50	17.0		124	#	124				424
13	25	17.9		125		125		125		425
L 13	50	18.0		126		126		126		426
14	25	19.3		127		127		127		427
L 14	50	19.5		128						



51072

TRIPLEplus socket wrench inserts

1/4"

ATORN®

 Quality
 Chrome-vanadium steel.

51072

Type

Mirror finished and chrome polished, drop-forged.

Use

Universal screw system for hexagonal, double hexagon and E-TX bolts and nuts.

Passt auch auf alle gängigen Zollgrößen.

TRIPLEplus mm	Hexagon	double hexagon	Inch	★ E-TX	51072	...
4.0	x	x	5/32	E 5	#	101
4.5	x	x	-	E 6	#	102
5.0	x	x	3/16	-	#	103
5.5	x	x	-	-	#	104
6.0	x	x	-	E 8		105
7.0	x	x	9/32	-		106
8.0	x	x	5/16	E 10		107
9.0	x	x	11/32	-	#	108
11.0	x	x	7/16	E 14	#	110
12.0	x	x	15/32	E 16	#	111
14.0	x	x	9/16	E 18	#	113

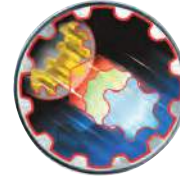

Hand Tools

51073

Double hexagonal socket wrench insert (inch) DIN 3124/ISO 2725

1/4"

BAHCO

 Quality
 Chromo-Extra.

51073

Type

Imperial sizes. High-performance inserts, thin-walled, with Dynamic-Drive profile.

Nickel-plated and chrome-plated, highly polished.

AF Inch	l mm	d ₁ mm	51073	...
3/16	22.2	7.7		101
7/32	22.2	8.5		102
1/4	22.2	9.3		103
9/32	22.2	10.5		104
5/16	22.2	11.5		105
11/32	22.2	12.6		106
3/8	22.2	13.8		107
7/16	22.2	15.4		108
1/2	22.2	17.5		109
9/16	23.0	18.8		110

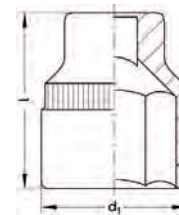

51079

Long double hexagonal socket wrench insert (inch) ISO 2725-1

1/4"

BAHCO

 Quality
 Chromo-Extra.

51079

Type

Long, imperial sizes. High-performance inserts, thin-walled, with Dynamic-Drive profile.

Nickel-plated and chrome-plated, highly polished.

AF Inch	l mm	d ₁ mm	51079	...
3/16	50.6	7.7		101
7/32	50.6	8.5		102
1/4	50.6	9.3		103
9/32	50.6	10.5		104
5/16	50.6	11.5		105
11/32	50.6	12.6		106
3/8	50.6	14.1		107
7/16	50.6	15.4	#	108
1/2	50.6	17.5	#	109
9/16	50.6	18.8	#	110

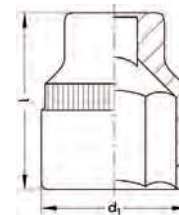

51074 - 51078

Screwdriver inserts

1/4"

51074

ATORN®

Type
Sleeves chrome-plated, blades made of special steel, burnished.

Quality
Chrome-vanadium steel.

51078

HAZET®

Quality
CVD-TiN coating for longer tool life.



51074 102-104



51078 101-106



51074 201-203



51078 201-203



51074 301-303



51078 301-303

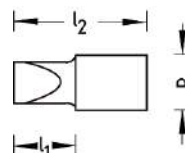

Blade thickness x -width mm	Size PH	Size PZ	ATORN®			HAZET®			
			l ₁ mm	l ₂ mm	d mm	51074	...	51078	...
⊖ 0.8 x 4.0			18	37	12.0			102	
⊖ 1.0 x 5.5			18	37	12.0			103	
⊖ 1.2 x 6.5			18	37	12.0			104	
⊖ 0.6 x 3.5			16	28	12.0				101
⊖ 0.8 x 4.0			16	28	12.0				102
⊖ 1.0 x 5.5			16	28	12.0				103
⊖ 1.2 x 8.0			16	28	12.0				105
⊖ 1.6 x 10.0			16	28	12.0				106
	⊕ PH 1		18	37	12.0			201	
	⊕ PH 2		18	37	12.0			202	
	⊕ PH 3		18	37	12.0		#	203	
	⊕ PH 1		16	28	12.0				201
	⊕ PH 2		16	28	12.0				202
	⊕ PH 3		16	28	12.0				203
	⊕ PZ 1		18	37	12.0			301	
	⊕ PZ 2		18	37	12.0			302	
	⊕ PZ 3		18	37	12.0		#	303	
	⊕ PZ 1		16	28	12.0				301
	⊕ PZ 2		16	28	12.0				302
	⊕ PZ 3		16	28	12.0				303

51082 - 51090

Hexagonal screwdriver inserts

1/4"



Type
Chrome-plated, drop-forged.

51082

ATORN®

Quality
Chrome-vanadium steel.

51086

GEDORE

Quality
Vanadium special steel.

51088

STAHLWILLE

Quality
Chrome alloy steel.

51090

HAZET

Quality
CVD-TiN coating for longer tool life.

AF mm	Length mm	ATORN®		GEDORE		STAHLWILLE		HAZET	
		51082	...	51086	...	51088	...	51090	...
3	28					101		102	201
3	37		101						
L 3	55							103	
4	28					102		104	202
4	37		102						
L 4	55							105	
5	28					103		106	203
5	37		103						
L 5	55							107	
6	28					104		108	204
6	37		104						
L 6	55							109	
8	28					105		110	205
8	37		105						

51082



51086



51088



51090



51088 L



51098

Hexagonal and TORX® screwdriver set

1/4"

**ATORN®**

Type

All tools are stored vibration-free.

Quality

Chrome-vanadium steel.

Note:

Torx® selector see cat.-no. 37930.

51098



Set contents

- 5 Inserts for hexagon socket head screws AF 3 / 4 / 5 / 6 / 8 mm
- 9 Inserts for inner TORX® screws T 8 / 9 / 10 / 15 / 20 / 25 / 27 / 30 / 40
- 1 Lever reversible ratchet with 2-component handle 150 mm
- 2 Extensions 50 / 105 mm

Set contents	Type	51098	...
17-piece	in sheet steel case with foam-material inlay		201

51099

TORX® set

1/4"

**ATORN®**

Type

All tools are stored vibration-free.

Quality

Chrome-vanadium steel.

Note:

Torx® selector see cat.-no. 37930.

51099

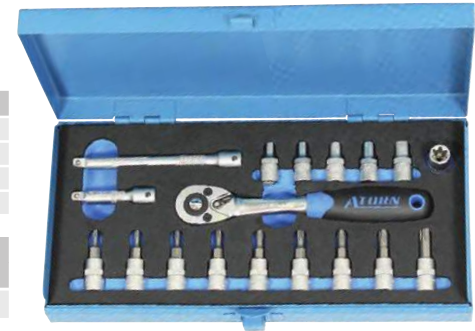

Set contents

- 6 Inserts for outer TORX® screws E 4 / 5 / 6 / 7 / 8 / 10
- 9 Inserts for inner TORX® screws T 8 / 9 / 10 / 15 / 20 / 25 / 27 / 30 / 40
- 1 Lever reversible ratchet with 2-component handle 150 mm
- 2 Extensions 50 / 105 mm

Set contents	Type	51099	...
18-piece	in sheet steel case with foam-material inlay		101

51091

TORX® set

1/4"

**STAHLWILLE®**

Quality

Chrome alloy steel.

Note:

Torx® selector see cat.-no. 37930.

51091



Set contents

- 6 Inserts for outer TORX® E 4 / 5 / 6 / 7 / 8 / 10
- 9 Inserts for inner TORX® T 8 / 9 / 10 / 15 / 20 / 25 / 27 / 30 / 40
- 1 Reversible ratchet
- 1 Driver with plastic grip
- 1 Handle with sliding piece
- 2 Extensions 54 / 150 mm
- 1 Universal joint

Set contents	Type	51091	...
21-piece	in sheet steel case		# 101

51097

TORX® set

1/4"

**GEDORE**

Quality

Vanadium special steel.

Note:

Torx® selector see cat.-no. 37930.

51097



Set contents

- 6 Inserts for outer TORX® E 4 / 5 / 6 / 7 / 8 / 10
- 9 Inserts for inner TORX® T 8 / 9 / 10 / 15 / 20 / 25 / 27 / 30 / 40

Set contents	Type	51097	...
15-piece	in plastic case		101

TORX® inserts | Reversible ratchets

51093 - 51096

TORX® screwdriver inserts



Use
For inner TORX® screws.

Note:
Torx® selector see cat.-no. 37930.



Type
Chrome-plated.
Quality
Chrome-vanadium steel.

51094
GEDORE
Type
Chrome-plated.
Quality
Vanadium special steel.

51096
HAZET
Quality
CVD-TIN coating for longer tool life.



Size	ATORN® 51093	...	GEDORE® 51094	...	HAZET® 51096	...
T						
8		101		101		101
9		102		102		102
10		103		103		103
15		104		104		104
20		105		105		105

Size	ATORN® 51093	...	GEDORE® 51094	...	HAZET® 51096	...
T						
25		106		106		106
27		107		107		107
30		108		108		108
40		109		109		109

51104 - 51105

TORX® socket wrench inserts



Type
Chrome-plated.
Use
For outer TORX® screws.
Quality
Vanadium steel.

Note:
Torx® selector see cat.-no. 37930.



51105
HAZET



Size	Length approx. mm	ATORN® 51104	...	HAZET® 51105	...
E					
4	25		101		101
5	25		102		102
6	25		103		103
7	25		104		104

Size	Length approx. mm	ATORN® 51104	...	HAZET® 51105	...
E					
8	25		105		105
10	25		106		106
11	25				107

51114 - 51120

Reversible ratchets DIN 3122/ISO 3315



Type
Chrome finish and polished. Extremely robust ratchet with switch knob for clockwise to counter-clockwise operation and vice versa. With ergonomically-shaped handle made of plastics.
Quality
Chrome-vanadium steel.

51114
GEDORE
Finely toothed (72 teeth, ratcheting angle 5°), with ball lock.

51116
STAHLWILLE
Finely toothed (60 teeth, rotational angle 6°) Quick reversal thanks to one-hand operation. With 2-component handle.
Quality
Chrome alloy steel.

51117
HAZET
Finely toothed (72 teeth, rotational angle 5°), makes working even extremely jammed fittings possible. Large reverse button on the top facilitates switching the direction of the ratchet. Protection against unintended switching due to a deeper lying reverse button. Tempered investment casting cover plate and reverse button for difficult operating conditions. Inductively hardened internal toothing guarantees high duty and long tool life. Robust body with forged, ergonomic handle. Non-slip 2-component handle for optimum handling.

51120
FACOM
Finely toothed (72 teeth, rotational angle 5°). The thumb rest enables the user to press onto the ratchet head without activating the reverse switch. Quick reversal thanks to one-hand operation.



Overall length mm	GEDORE® 51114	...	STAHLWILLE® 51116	...	HAZET® 51117	...	FACOM® 51120	...
117							201	
118				201				
119						101		
129	101							

Hand Tools

51123

Readyflex® Freiraumknarre®

1/4"



Type
With reverse function ring, finely toothed (72 teeth), flexible, 7 switching steps.



51123

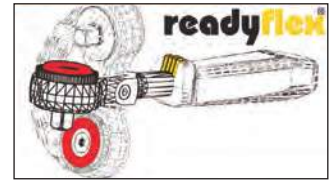

Overall length	51123	...
mm		
137		301

51125 - 51133

Reversible ratchets DIN 3122/ISO 3315

1/4"

Type
Chrome-plated, extremely robust ratchets with reversible knob for clockwise and counterclockwise operation and ergonomically-shaped handle made of plastics.
Quality
Chrome-vanadium steel.



51126 201
With reverse lever and quick-release push button. Finely toothed, (72 teeth). Non-slip 2-component handle with hanging hole.



51127 101
With reverse lever and quick-release push button. Finely toothed (72 teeth, rotational angle 5°).



51129 101
With reverse lever, locking mechanism in centre position and ball lock. Oval head. 24 teeth, ratcheting angle 15°.



51129 102
Type
With reverse lever, quick-release push button and ball lock. Finely toothed, 40 teeth, ratcheting angle 9°. Non-slip 2-component handle with attachment eye.



51130 201
With reverse lever, 22 teeth. With 2-component handle.

Quality
Chrome alloy steel.



51130 203
With reverse lever, QuickRelease safety lock and 2-component handle, 80 teeth, working angle of only 4.5°.

Quality
Chrome alloy steel.



51130 204
With reverse lever, QuickRelease safety lock and 2-component handle, 22 teeth.

Quality
Chrome alloy steel.



51132 101
With reverse lever.

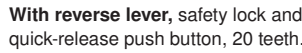

51132 102
With reverse lever, safety lock and quick-release push button, 20 teeth.



51133 101
With reverse lever. 72 teeth, return angle 5°. Nickel-plated and chrome-plated, highly polished. With 2-component handle.



51125 100
With reverse lever and quick-release push button. Chrome-plated, 36 teeth.



51126



51127 101



51129 101



51129 102



51130 201



51130 203



51130 204



51132 101



51132 102



51133 101



51125 100



51129 102

	ATORN®		GEDORE		STAHLWILLE®		HAZET		BAHCO		SALTUS			
Overall length	51126	...	51127	...	51129	...	51130	...	51132	...	51133	...	51125	...
mm														
115			101								101			
115											102			
117										201				
117										203	NEW			
127						101								
129						102								
130												101		
145	201													
153								204						100

Hand Tools

51134

T-handle reversible ratchet

1/4"



Type
With quickly releasable safety lock.

Use
Combines the advantages of a T-handle socket wrench and a reversible ratchet. Both powerful and sensitive operation are possible.



51134

Overall length	51134	...
mm		
100		101



51138

Extendible reversible ratchet

1/4"

Type
- 3 adjustable and lockable positions from 190 to 250 mm
- Finely toothed, (72 teeth).
- Insert quick release
Quality
Chrome-vanadium steel, matt chrome-plated.



51138

Adjusting range	51138	...
mm		
190 - 250		101

51135

Readyflex® Freiraumknarre®

1/4"



Type
Chrome-plated, with **reverse lever** and **flexible lever arm**. Joint lockable in 7 angle positions with the flex-stop variomatic.

Use
This ratchet combines all the advantages of a ratchet with a flexible lever arm with those of a ratchet with a rigid lever arm. It guarantees full leverage, especially in angled positions. It is therefore suitable for application in hard-to-reach areas.
Quality
Chrome-vanadium steel.



51135

Overall length	51135	...
mm		
145		101



51136

Zyklop ratchet

ZYKLOP

1/4"



Type
- Flywheel mass design and anti-slip freewheel sleeve for a high working speed
- Freely swiveling ratchet head
- Defined position at 0°, 90° to the left and right as well as 15° from 90° towards the inside
- Used like a conventional screwdriver when in the 0° position
- Push-button release
- Left/right switching
- Finely toothed
- Small return angle of 5°
- Multi-component Kraftform handle for fatigue-free working



The ratchet head swivels freely and can be unlocked in any position by sliding the switch which is located on both sides.



The socket lock accelerates the fitting and removal of inserts and extensions. The ball lock provides a secure fit for sockets and accessories and provides reliable safety while tightening. Simply press the release button and tool exchange is possible in any defined position.



The flywheel design accelerates the screwing process.



The Zyklop ratchet is quickly and easily reversible in any position by means of the knurl.



51136

Overall length	51136	...
mm		
152		101

51137

Zyklop ratchet set

1/4"



51137

Wera
Werkzeug und mehr
Type

In folding pocket for attaching to your belt.
With the Wera Zyklop ratchet, you have 6 tools in one:

1. Fine-tooth ratchet,
2. Flexible ratchet,
3. Angled ratchet,
4. Ratchet with safety lock,
5. Heavy-duty ratchet,
6. Screwdriver.



Set contents

- | | |
|---|--|
| 1 | Zyklop ratchet |
| 7 | Zyklop socket wrench inserts AF 5.5 / 6 / 7 / 8 / 10 / 12 / 13 x 23 mm |
| 4 | Bits for Hex-Plus hexagon socket head screws 3 / 4 / 5 / 6 x 50 mm |
| 1 | Bit for slotted screws 1 x 5.5 x 50 mm |
| 3 | Bits for Phillips recess head screws PH 1 / 2 / 3 x 50 mm |
| 2 | Bits for Phillips recess head screws PZ 1 / 2 x 50 mm |
| 6 | Bits for TORX® screws T 10 / 15 / 20 / 25 / 27 / 30 x 50 mm |
| 1 | Zyklop connection part 1/4 inch hexagonal x 1/4 inch square |
| 1 | Zyklop extension with freewheel sleeve 150 mm |

Set contents	Type	51137	...
26-piece	in folding pocket		101

51140 - 51145

Drive elements

1/4"

Type
Chrome-plated, drop-forged.
Quality
Chrome-vanadium steel.

51140
ATORN®

51140 301

Holder

Type

With inner and outer square. Length 150 mm.

51140 203

HW
Flexible bit holder

Type

With flexible shank, large socket depth. Shaft stands a torque value of 12 Nm in both directions. Shaft length 100 mm.

51143

STAHLWILLE®

51143 102

STAHLWILLE®

Holder

Type

With 2-component handle.

Quality

Chrome alloy steel.

51145

STAHLWILLE®

Type

With QuickRelease safety lock.

Quality

Chrome alloy steel.

51144

HAZET®



51140 201



51145 101



51140 301



51140 301



51143 102



51140 203



51140 204



51143 104



51145 104



51144 104



51143 105



51144 105



51143 106



51143 107



ATORN®

STAHLWILLE®

STAHLWILLE®

HAZET®

	51140	...	51143	...	51145	...	51144	...
Handle with sliding piece			201				101	101
Driver			301 NEW		102			
Flexible driver			203					
Universal joint			204	104		104		104
Adapter 1/4 inch <input type="checkbox"/> x 3/8 inch <input type="checkbox"/>			205	105				105
Adapter 1/4 inch <input type="checkbox"/> x 1/2 inch <input type="checkbox"/>				106				
FixGRIP-Adapter 1/4 inch <input type="checkbox"/> x 3/8 inch <input type="checkbox"/>				107				

51153 - 51164

Extensions

1/4"

Type
Chrome-plated, drop-forged.
Quality
Chrome-vanadium steel.

51153
ATORN®

51156
GEDORE

51157
STAHLWILLE

Quality
Chrome alloy steel.

51157 105
STAHLWILLE

Flexible extension
Load capacity 5 Nm. Only for clockwise operation.

51159
HAZET

51162
FACOM

51164
STAHLWILLE
With QuickRelease safety lock.
Quality
Chrome alloy steel.

51159 100



51156 201



51164 101



51157 102



51153 103



51156 202



51159 102



51164 102



51162 104



51157 105



	ATORN®		GEDORE		STAHLWILLE		HAZET		FACOM		STAHLWILLE	
Length mm	51153	...	51156	...	51157	...	51159	...	51162	...	51164	...
25									100			
55		101		201		101		101				101
100		102				102				102		
150		103		202		103		102				102
250										104		
356												103
402								105				
152						105						

51165

Extensions with lock

1/4"

FACOM

Type
Chrome-plated, polished.

Use
The locking mechanism prevents the unintentional drop-off of the socket wrenches.

Quality
Vanadium steel.

Length mm	51165	...
100		201
250		203

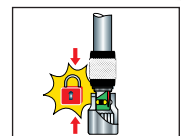
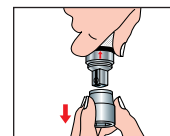

51165



51167

Cardan extensions

1/4"

GEDORE

Type
With ball lock.

Use
The extension allows a turning of 15°.

Length mm	51167	...
55		101
97		102
148		103



51167

51168

Swivelling extensions

1/4"

HAZET

Type
Chrome-plated, polished.

Use
With ball-type, conical outer square.
Allows a flex angle to any direction of 8°.

Quality
Chrome-vanadium steel.

Length mm	51168	...
25.0		101
101.5		102

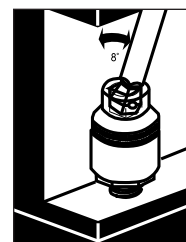

51168 101

51168 102



51173

Hexagonal socket wrench set

3/8"

ATORN®

 Quality
 Chrome-vanadium steel.

51173

Type

All tools are stored vibration-free.

Set contents	
17	Hexagonal inserts with energy profile AF 6 / 7 / 8 / 9 / 10 / 11 / 12 / 13 / 14 / 15 / 16 / 17 / 18 / 19 / 20 / 21 / 22 mm
1	Adapter 1/2 inch x 3/8 inch
1	Reversible ratchet
1	Universal joint
3	Extensions 50 / 75 / 150 mm

Set contents	Type	51173	...
23-piece	in sheet steel case with foam-material inlay		101



51175

Hexagonal socket wrench set

1/4"

3/8"

HAZET®

 Quality
 Chrome-vanadium steel.

51175

Set contents	
12	Hexagonal inserts with traction profile AF 4 / 4.5 / 5 / 5.5 / 6 / 7 / 8 / 9 / 10 / 11 / 12 / 13 mm
5	Bits for hexagon socket head screws AF 3 / 4 / 5 / 6 / 8 mm
4	Bits for slotted screws 0.5 x 4 / 0.6 x 4.5 / 0.8 x 5.5 / 1.0 x 6 mm
2	Bits for Phillips recess head screws PH 1 / 2
2	Bits for Phillips recess head screws PZ 1 / 2
1	Adapter 1/4 inch square (hollow) x 1/4 inch hexagonal (hollow)
1	Reversible ratchet
1	Driver with plastic grip
1	Universal joint
1	Extension 101.5 mm
12	Hexagonal inserts with traction profile AF 10 / 11 / 12 / 13 / 14 / 15 / 16 / 17 / 18 / 19 / 21 / 22 mm
1	Adapter 3/8 inch square (hollow) x 1/4 inch hexagonal (hollow)
1	Reversible ratchet
1	Universal joint
1	Extension 150 mm

Set contents	Type	51175	...
46-piece	in SmartCase		201



51178

Hexagonal socket wrench set

3/8"

GEDORE

 Quality
 Vanadium 31CrV3.

51178

Type

With tempered hexagonal UD inserts.

Set contents	
12	Hexagonal inserts with UD profile AF 6 / 7 / 8 / 9 / 10 / 11 / 13 / 14 / 15 / 16 / 17 / 19 mm
1	Lever reversible ratchet
1	Handle with sliding piece
1	Universal joint
2	Extensions 125 / 250 mm

Set contents	Type	51178	...
17-piece	in sheet steel case		101



51180

Hexagonal socket wrench set

3/8"

STAHLWILLE®

 Quality
 Chrome alloy steel.

51180

Type

Chrome-plated.

Set contents	
14	Inserts with AS-drive profile AF 8 / 9 / 10 / 11 / 12 / 13 / 14 / 15 / 16 / 17 / 18 / 19 / 21 / 22 mm
1	Reversible ratchet
1	Handle with sliding piece
1	Universal joint
2	Extensions 76 / 240 mm

Set contents	Type	51180	...
19-piece	in sheet steel case		102



Socket Wrenches Sets

51181

Hexagonal socket wrench set

3/8"



Quality
Chrome-vanadium steel.

51181



Set contents	
11	Hexagonal inserts with traction profile AF 8 / 10 / 11 / 12 / 13 / 14 / 15 / 17 / 19 / 21 / 22 mm
1	Reversible ratchet
1	Handle with sliding piece
1	Universal joint
2	Extensions 126 / 254 mm

Set contents	Type	51181	...
16-piece	in SmartCase		101

51184

Double hexagonal socket wrench set

3/8"



Quality
Vanadium 31CrV3.

51184



Set contents	
12	Double hexagonal inserts with UD profile AF 6 / 7 / 8 / 9 / 10 / 11 / 13 / 14 / 15 / 16 / 17 / 19 mm
1	Reversible ratchet
1	Handle with sliding piece
1	Universal joint
2	Extensions 125 / 250 mm

Set contents	Type	51184	...
17-piece	in sheet steel case		101

51185

Double hexagonal socket wrench set

3/8"



Type
Chrome-plated.

Quality
Chrome alloy steel.

51185



Set contents	
11	Double hexagonal inserts with AS-drive profile AF 8 / 10 / 11 / 12 / 13 / 14 / 15 / 16 / 17 / 18 / 19 mm
1	Reversible ratchet
1	Universal joint
2	Extensions 76 / 240 mm

Set contents	Type	51185	...
15-piece	in sheet steel case		101

51188

Double hexagonal socket wrench set

3/8"



Type
With Quick-Release system
(one-hand safety lock).

Quality
Chrome alloy steel.

51188



Set contents	
14	Double hexagonal inserts with AS-drive profile AF 8 / 9 / 10 / 11 / 12 / 13 / 14 / 15 / 16 / 17 / 18 / 19 / 21 / 22 mm
1	Reversible ratchet
1	Handle with sliding piece
1	Universal joint
2	Extensions 76 / 240 mm

Set contents	Type	51188	...
19-piece	in plastic case		101

51186

Double hexagonal socket wrench set



Type
Chrome-plated.

Quality
Chrome alloy steel.

51186



Set contents

- 11 Double hexagonal inserts with AS-drive profile AF 8 / 10 / 11 / 12 / 13 / 14 / 15 / 16 / 17 / 18 / 19 mm
- 1 Hexagonal insert with AS-drive profile AF 16 mm-5/8 inch with rubber insert for spark plugs
- 7 Inserts for hexagon socket head screws AF 3 / 4 / 5 / 6 / 7 / 8 / 10 mm
- 1 Reversible ratchet
- 1 Handle with sliding piece
- 1 Universal joint
- 2 Extensions 76 / 240 mm

Set contents	Type	51186	...
24-piece	in sheet steel case		101

51187

Hexagonal socket wrench set



Quality
Chrome-vanadium steel.

51187



Set contents

- Ⓣ 16 Hexagonal inserts with traction profile AF 6 / 7 / 8 / 9 / 10 / 11 / 12 / 13 / 14 / 15 / 16 / 17 / 18 / 19 / 21 / 22 mm
- ⊖ 3 Inserts for slotted screws 1.0 x 5.5 / 1.2 x 8.0 / 1.6 x 10.0 mm
- ⊕ 3 Inserts for Phillips recess head screws PH 1 / 2 / 3
- 4 Inserts for hexagon socket head screws AF 4 / 5 / 6 / 8 mm
- 1 Reversible ratchet
- 1 Handle with sliding piece
- 1 Universal joint
- 3 Extensions 74 / 126 / 254 mm

Set contents	Type	51187	...
32-piece	in plastic case		101

51189

Hexagonal and Double hexagonal socket wrench set



Quality
Chrome-vanadium steel.

51189



Set contents

- Ⓣ 3 Hexagonal inserts with traction profile AF 6 / 7 / 8 mm
- Ⓣ 14 Double hexagonal inserts with traction profile AF 9 / 10 / 11 / 12 / 13 / 14 / 15 / 16 / 17 / 18 / 19 / 20 / 21 / 22 mm
- Ⓣ 14 Double hexagonal inserts with long traction profile AF 9 / 10 / 11 / 12 / 13 / 14 / 15 / 16 / 17 / 18 / 19 / 20 / 21 / 22 mm
- ⊖ 3 Inserts for slotted screws 1.0 x 5.5 / 1.2 x 8.0 / 1.6 x 10.0 mm
- ⊕ 3 Inserts for Phillips recess head screws PH 2 / 3 / 4
- 9 Inserts for hexagon socket head screws AF 3 / 4 / 5 / 6 / 7 / 8 / 9 / 10 / 12 mm
- 1 Reversible ratchet
- 1 Flex handle
- 1 Driver
- 1 Handle with sliding piece
- 1 Universal joint
- 4 Extensions 74 / 150 / 202 / 304 mm
- 1 Flexible extension 210 mm
- 1 Adapter 1/4 inch ■ x 3/8 inch □

Set contents	Type	51189	...
57-piece	in metal case with plastic insert	#	201



Bit rails | Socket wrench inserts

51218

Bit rails, magnetic (empty)

3/8"



Type

Outer square suitable for size 14 socket wrench inserts nominal size 10 (3/8 inch). **2 additional inner square wrench adapters for ratchets, sliding handles, extension pieces, etc.** A strong magnet allows for a secure fastening of the rail to metal objects. Additional boreholes allow the fastening to non-metallic objects and walls.



51218

The bits are held securely by the ball by means of turning them 90°.

Turning them 90° in the opposite direction will release the bits so that they can be removed.

Tools not included.

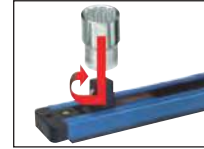

for inserts pcs.	Length mm	Width mm	Weight g	51218	...
14	480	33	450		101

Hand Tools

51222 - 51226

Hexagonal socket wrench inserts DIN 3124/ISO 2725

3/8"



Type

Chrome-plated, drop-forged.

Quality

Chrome-vanadium steel.

51222



With Energy profile.

51223



With UD profile.

Quality

31 Cr V3.

51224



With AS-drive profile.

Quality

Chrome alloy steel.

51226



With Tractions profile.

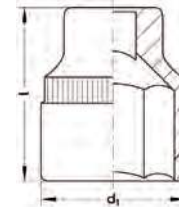

51222



51223



51224



51226



AF mm	l approx. mm	d ₁ approx. mm	ATORN®		GEDORE		STAHLWILLE®		HAZET®	
			51222	...	51223	...	51224	...	51226	...
6	26	9.7		101		201			#	301
7	26	10.5		102		202				302
8	26	12.0		103		203		#	203	303
9	26	13.2		104		204				304
10	27	14.5		105		205			205	305
11	27	15.8		106	#	206	#	206	#	306
12	28	17.0		107		207	#	207	#	307
13	29	18.3		108		208		208		308
14	29	19.5		109		209		209		309
15	30	20.8		110		210	#	210		310
16	30	22.0		111		211		211		311
17	30	23.3		112		212		212		312
18	31	24.5		113		213	#	213		313
19	31	26.0		114		214		214		314
20	32	27.0		115					#	315
21	32	28.5	#	116		216				316
22	33	29.5		117		217	#	217		317

When you are king ...



... your wishes come true.



Performance requires quality

www.atorn.de



51229 - 51232

Double hexagonal socket wrench inserts DIN 3124/ISO 2725



Type
Chrome-plated, drop-forged.

51229
GEDORE
With UD profile.
Quality
31 Cr V3.

51232
HAZET
With Tractions profile.
Quality
Chrome-vanadium steel.



AF mm	l approx. mm	d ₁ approx. mm	GEDORE		HAZET	
			51229	...	51232	...
6	28	9.7	#	098		
7	28	11.0		099		
8	28	12.1		100		
9	24	13.0		101		101
10	25	14.5		102		102
11	27	16.0		103		103
12	27	17.0		104		104
13	28	18.5		105		105
14	28	19.5		106		106

AF mm	l approx. mm	d ₁ approx. mm	GEDORE		HAZET	
			51229	...	51232	...
15	29	21.0	#	107		107
16	29	28.0		108		108
17	30	23.5		109		109
18	30	24.5		110		110
19	31	26.5		111		111
20	31	27.0			#	112
21	31	28.5			#	113
22	32	29.5	#	114	#	114

51234 - 51235

Long double hexagonal socket wrenches inserts



Use
For deeply set screws and protruding bolts.

Note:
Cat.-no. 51235 214-215 are in compliance with DIN 3124/ISO 2725.

51234
STAHLWILLE
Type
Chrome-plated, with AS-Drive profile.
Quality
HPQ heavy-duty steel.

51235
HAZET
Type
Chrome-plated, drop-forged and polished.
With Tractions profile.
Quality
Chrome-vanadium steel.

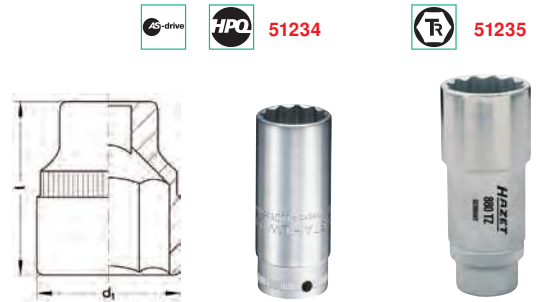

AF mm	l approx. mm	d ₁ approx. mm	STAHLWILLE		HAZET	
			51234	...	51235	...
10	54	14.4		202		202
11	54	15.7		203		203
12	54	17.0		204		204
13	54	18.3		205		205
14	57	19.5	#	206		206
15	60	20.6		207		207
16	60	21.8		208		208

AF mm	l approx. mm	d ₁ approx. mm	STAHLWILLE		HAZET	
			51234	...	51235	...
17	62	23.0		209		209
18	65	24.3		210		210
19	65	25.5		211		211
20	68	26.6			#	212
21	68	28.0				214
22	68	29.4				215

51238

Universal socket wrenches insert -Gripper-



Type
Replaces all hexagonal socket wrench inserts between AF 7 and 19 mm.
The 54 steel pins automatically fit to any nut or outer head screw.
Special round-pin design protects screw heads against damage.
Each pin has a resilience with a strong back stop for optimum grip of screw or nut.

Use
With this multi-purpose tool, triangle, square, hexagonal and TORX® profiles, as well as wing nuts, clip bolts and eyebolts and other polygon bolts and nuts - also imperial size connections - are gripped securely.
Quality
Housing made of alloyed steel.

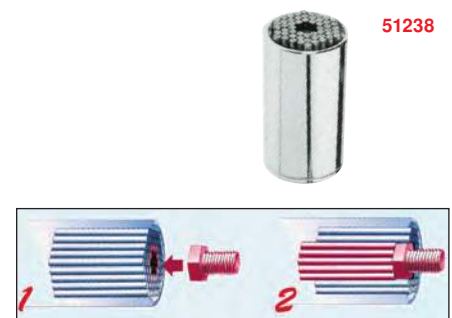

Length mm	Ø mm	51238	...
53.5	25.4		401

Hand Tools

51241

Joint hexagonal socket wrench inserts



Type
Short, chrome-plated. With Tractions profile.
Use
For hard-to-reach areas.

Quality
Chrome-vanadium steel.

Note:
Also available as set.
Please send us your enquiry!

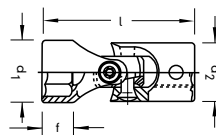

AF mm	l mm	d ₁ mm	d ₂ mm	f mm	51241	...
10	43	13.8	19	6.8		201
11	43	15.0	19	6.8	#	202
12	44	16.6	19	7.3		203
13	44	17.8	19	7.3		204
14	45	19.0	19	9.3		205

AF mm	l mm	d ₁ mm	d ₂ mm	f mm	51241	...
15	45	20.4	19	9.3		206
16	46	22.0	19	9.2		207
17	46	22.8	19	9.2		208
18	47	24.5	19	10.2		209
19	48	25.2	19	11.2		210

51236

Double hexagonal socket wrench inserts (inch) ISO 2725-1



Type
Imperial sizes. High-performance inserts, thin-walled, with Dynamic-Drive profile.
Nickel-plated and chrome-plated, highly polished.

Quality
Chromo-Extra.

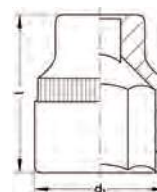

AF inch	l mm	d ₁ mm	51236	...
1/4	25.8	10.0		101
5/16	25.8	11.4		102
3/8	25.8	14.3		103
7/16	25.8	15.7		104
1/2	25.8	18.0		105
17/32	25.8	18.8	#	106
9/16	27.4	19.6		107

AF inch	l mm	d ₁ mm	51236	...
19/32	27.8	20.4	#	108
5/8	28.3	21.1		109
11/16	28.8	23.6	#	110
3/4	30.2	25.1		111
13/16	31.3	26.7		112
7/8	32.5	29.1		113

51237

Long double hexagonal socket wrench inserts (inch) ISO 2725-1



Type
long, imperial sizes. High-performance inserts, thin-walled, with Dynamic-Drive profile. Nickel-plated and chrome-plated, highly polished.

Quality
Chromo-Extra.

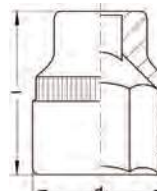

AF inch	l mm	d ₁ mm	51237	...
1/4	56	10.0	#	101
5/16	56	11.4		102
3/8	56	14.3	#	104
7/16	56	15.7		105
1/2	60	18.0		106
9/16	60	19.6		107

AF inch	l mm	d ₁ mm	51237	...
19/32	60	20.4	#	108
5/8	60	21.1	#	109
11/16	60	23.6	#	110
3/4	60	25.2	#	111
13/16	60	26.7	#	112

51244

Screwdriver inserts



Type
Sleeves chrome-plated, blades made of special steel, burnished. Square drive C10 DIN 3120, ISO 1174. With ball-retaining groove.

Quality
Vanadium special steel.

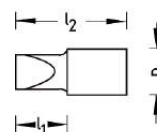

Blade thickness x width mm	l ₁ mm	l ₂ mm	d mm	51244	...
1.0 x 5.5	27	55	17.5	#	201
1.2 x 8.0	27	55	17.5	#	202
1.6 x 10.0	23	55	17.5	#	203

Size	l ₁ mm	l ₂ mm	d mm	51244	...
PH 1	27	55	17.5	#	301
PH 2	23	55	17.5	#	302
PH 3	23	55	17.5	#	303

51246 - 51250

Hexagonal Screwdriver inserts DIN 3120/ISO 1174

3/8"



Type
Chrome-plated.
Quality
Chrome-vanadium special steel.

51246
ATORN®
With ball-retaining groove and lateral bore.

51247
GEDORE
With ball-retaining groove.

51248
STAHLWILLER
Chrome alloy steel.

51250
HAZET
Long type.
Sleeve chrome-plated,
CVD-TiN-coated blade.

AF	l	d	ATORN®	GEDORE	STAHLWILLER	HAZET
mm	approx. mm	approx. mm	51246	...	51247	...
3	43.5	17.5	101			101
L 3	50.0	17.0				301
4	52.0	17.5	102		202	102
L 4	55.0	17.0				302
5	52.0	17.5	103		203	103
L 5	60.0	17.0				303
6	52.0	17.5	104		204	104
L 6	65.0	17.0				304
7	52.0	18.0	105			105
L 7	70.0	19.0				305
8	52.0	18.0	106		206	106
L 8	75.0	19.0				306
9	52.0	19.0	107			
L 9	80.0	19.0				307
10	52.0	19.0	108		208	108
L 10	85.0	19.0				308
12	52.0	19.0	109			
L 12	90.0	19.0				309

51246



51247



51248



51250

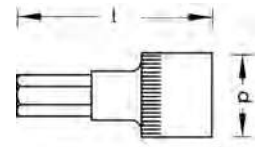

51254

Long hexagonal ball head screwdrivers inserts

3/8"



Type
Chrome-plated, with ball-retaining groove. Allows for a flex angle of approx. 15 - 20°.

Quality
Chrome-vanadium special steel, burnished.

AF	l	d	51254	...
mm	mm	mm		
4 L	132	17.5	100	
5 L	132	17.5	101	
6 L	132	17.5	102	

AF	l	d	51254	...
mm	mm	mm		
8 L	134	17.5	104	
10 L	134	19.0	105	

51254



51254 105

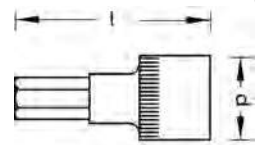

51253

Hexagonal ball head screwdriver inserts

3/8"



Type
Sleeve chrome-plated, blade CVD-TiN coated.
Allows a flex angle of 20°.

Quality
Sleeve chrome-vanadium steel.

AF	l	d	51253	...
mm	mm	mm		
5	116	17	201	
6	116	17	202	
7	116	19	203	

AF	l	d	51253	...
mm	mm	mm		
8	116	19	204	
10	116	19	205	

51253

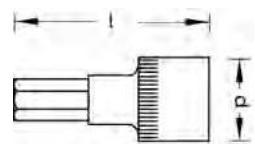

51256

Hexagonal screwdriver inserts (inch)

3/8"



Type
Sleeve chrome-plated, CVD-TiN coated blade.

Quality
Sleeve chrome-vanadium steel.

AF	l	d	51256	...
inch	mm	mm		
1/8	50	17	301	
5/32	55	17	302	
3/16	60	17	303	
7/32	65	17	304	

AF	l	d	51256	...
inch	mm	mm		
1/4	70	19	305	
5/16	75	19	306	
3/8	80	19	307	

51256

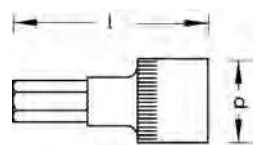

Hand Tools

51257 TORX® set

GEDORE

Quality
Vanadium special steel.

Note:
Torx® selector see cat.-no. 37930.

Set contents	Type	51257	...
15-piece	in plastic case		101

Set contents

- 8 Inserts for outer TORX® E 5 / 6 / 7 / 8 / 10 / 11 / 12 / 14
- 7 Inserts for inner TORX® T 20 / 25 / 27 / 30 / 40 / 45 / 50



51258 - 51261 TORX® screwdriver inserts

Type
Chrome-plated.

Use
For inner TORX® screws.

Note:
TORX® selector, see cat. no. 37930.



Size	Length approx. mm	51258	...	51259	...	51261	...
T 15	43.5						101
20	43.5						102
20	47.0	101					
20	49.0			#	201		
25	43.5						103
25	47.0	102					
25	49.0				202		
27	43.5						104
27	47.0	#	103				
27	49.0			#	203		
30	43.5						105

Size	length approx. mm	51258	...	51259	...	51261	...
T 30	47.0			104			
30	49.0					204	
40	43.5						106
40	47.0			105			
40	49.0					205	
45	43.5						107
45	47.0			106			
45	49.0					206	
50	44.5						108
50	47.0			107			
50	49.0					207	

51263 - 51264 TORX® socket wrench inserts

Type
Chrome-plated.

Use
For outer TORX® screws.

Note:
TORX® selector, see cat. no. 37930.



Size	Length approx. mm	51264	...	51263	...	
E 5	28		#	101	#	201
6	28		#	102	#	202
7	28		#	103	#	203
8	28			104		204

Size	Length approx. mm	51264	...	51263	...			
10	28			105		205		
11	28			#	106	#	206	
12	28					107		207
14	28					108		208

51265 XZN screwdriver inserts

HAZET

Type
Sleeve chrome-plated, blade CVD-TiN coated.

Use
For trisquare socket head screws (XZN).

Quality
Sleeve chrome-vanadium steel.



Size	Length mm	51265	...	
M 5	40		#	201
6	40			202
8	41			203

Size	Length mm	51265	...	
L 8	88			204
10	42			205
L 10	89			206

51275 - 51279

Reversible ratchets DIN 3122/ISO 3315

3/8"

Type

- Chrome-plated
- Extremely robust ratchet with **switch knob for clockwise to counter-clockwise operation and vice versa**
- Ergonomic plastic handle

Quality

Chrome-vanadium steel.

51275

GEDORE

Type

- **Fine-toothed (72 teeth, rotational angle 5°)**
- Ground
- Ball lock

51276

STAHLWILLE

Type

- **Finely toothed (60 teeth, rotational angle 6°)**
- For application in hard-to-reach areas.
- With 2-component handle.

Quality

Chrome alloy steel.

51279

FACOM

Type

- **Finely toothed (72 teeth, rotational angle 5°)**
- The thumb rest enables the user to press onto the ratchet head without activating the reverse switch.
- Quick reversal thanks to one-hand operation.



51275



51276



51279

	GEDORE	...	STAHLWILLE	...	FACOM	...
Overall length mm	51275		51276		51279	
175						101
194				101		
200		101				

51281

Readyflex® Freiraumknarre®

3/8"

carolus

Type

With reverse function ring, finely toothed (72 teeth), 7 switch steps, chrome-plated. Lockable by means of yellow Flex button. Extremely robust ratchet, turning the head reverses direction from clockwise to counter-clockwise and vice versa. With ergonomically-shaped handle made of plastics. **With flexible lever arm, joint can be arrested in any angle position.** The sliding guide in inner ring (1) enables the user to press onto the ratchet head without activating the reverse switch. Reverse function by means of one-hand operation on **outer ring (2)**.

Use

This ratchet combines all the advantages of a ratchet with a flexible lever arm with those of a ratchet with a rigid lever arm. It guarantees full leverage, especially in angled positions. It is therefore suitable for application in hard-to-reach areas.

Quality

Chrome-vanadium steel.



51281



Overall length mm	51281	...
230		201

51282

Joint reversible ratchet

3/8"

STAHLWILLE

Type

Finely toothed (60 teeth). Handle may be raised or lowered by approx. 90°. Lockable in following positions: straight, 30° up, 60° up, 30° down. Unlocked by depressing button in handle, DBG.M.

Quality

Chrome alloy steel.



51282

Overall length mm	51282	...
300	#	101

51283 - 51288

Reversible ratchets DIN 3122/ISO 3315

3/8"

Type

Chrome-plated, extremely robust ratchets with reversible knob for clockwise and counterclockwise operation and ergonomically-shaped handle made of plastics.

Quality

Chrome-vanadium steel.

51286 101



With reverse lever and quick-release push button. Finely toothed, 72 teeth. Non-slip 2-component handle with hanging hole.

51284 102



With reverse lever and push-button release, drop-shaped head for the tightest bolts, non-slip 2-component handle with hanging hole. Finely toothed with 60 teeth.

Quality

31 Cr V3.

51285 101



With reverse lever, 30 teeth.

Quality

Chrome alloy steel.

51285 103



Type

With reverse lever, QuickRelease safety lock and 2-component handle, 80 teeth.

Quality

Chrome alloy steel.

51287 101



With reverse lever, polished, 30 teeth.

51287 102



With reverse lever, polished, 30 teeth. Additionally with safety lock and quick-release push button.

51288 201



With reverse lever, nickel- and chrome-plated. Rounded and highly polished surfaces without sharp edges. 80 teeth, return angle 4.5°. 2 claws supporting 7 teeth on each in contact with the gear. Exceeds torque requirements as per ISO and ASME. With warm, comfortable 2-component handle, non-slip with extended width.

Quality

Vanadium-extra, precision-forged and heat-resistant.

51283 100



With reverse lever and quick-release push button. Chrome-plated, 36 teeth.



51286 101



51284 102



51285 101



51285 103



51287 101



51287 102



51288 201



51283 100

	ATORN®	...	GEDORE	...	STAHLWILLE	...	HAZET	...	BAHCO	...	SALTUS	...
Overall length	51286	...	51284	...	51285	...	51287	...	51288	...	51283	...
mm												
190			101									
193							101					
193							103	NEW				
199									101			
199									102			
200					102							
205											201	

51289

One-Hand reversible ratchets DIN 3120/ISO 1174

3/8"



Type

Nickel-plated and chrome-plated, highly polished. Smooth running one-hand reverse ring on the handle for reversal of operation by a simple, short turn. Integrated quick-turning disc on the square section for easier tightening and loosening of screw

connections. Unlocking device of ball catch for effortless and quick push-button exchange of socket wrench bits. **Fine-pitched teeth (72 teeth)**, return angle 5°. 2-component plastic handle with attachment eye.

Quality
Vanadium-extra.



51289 101

Overall length	51289	...
mm		
215		101



51289

Reversible ratchet with rotary handle DIN 3122/ISO 3315

3/8"



Type

Satinized and chrome-plated. Ratcheting angle = 0° with rotatable handle. Ratcheting angle = 6° for standard usage (finely toothed 60 teeth).

Simple unlocking of the tools by pushing a button even with oily hands or gloves. Ergonomically shaped ratchet head. Heel of the hand can be used to prevent sliding off and to support screwing.



51289 201

Overall length	51289	...
mm		
235		201



51290

Joint reversible ratchet

3/8"



Type
With reverse lever.
Chrome finish and polished.

Extremely robust ratchet with clockwise and counter-clockwise operation, swivelling ratchet head and ergonomic plastic handle.
Quality
Chrome-vanadium steel.



51290

Overall length	51290	...
mm		
218		101

51294

Zyklus ratchet

ZYKLOP 3/8"



Type
- Flywheel mass design and anti-slip freewheel sleeve for a high working speed
- Freely swivelling ratchet head
- Defined position at 0°, 90° to the left and right as well as 15° from 90° towards the inside
- Used like a conventional screwdriver when in the 0° position
- Push-button release
- Left/right switching
- Finely toothed
- Small return angle of 5°
- Multi-component Kraftform handle for fatigue-free working



The ratchet head swivels freely and can be unlocked in any position by sliding the switch which is located on both sides.



The socket lock accelerates the fitting and removal of inserts and extensions. The ball lock provides a secure fit for sockets and accessories and provides reliable safety while tightening. Simply press the release button and tool exchange is possible in any defined position.



The flywheel design accelerates the screwing process.



The Zyklus ratchet is quickly and easily reversible in any position by means of the knurl.



51294

Overall length	51294	...
mm		
199		101

51299 - 51304

Drive elements

3/8"

Type
Chrome-plated, drop-forged.
Quality
Chrome-vanadium steel.

51301
 Quality
Chrome alloy steel.



51302
 With QuickRelease safety lock.
Quality
Chrome alloy steel.



51300 202
Crank
With rotating handle.



51303
Driver



51300 201



51302 101



51304 102

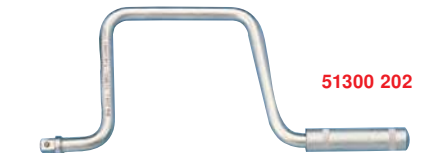

51300 202



	51299	...	51300	...	51301	...	51302	...	51303	...	51304	...
Handle with sliding piece	101		201				101		101			
Driver												102
Crank			#	202								
Universal joint	103		203		#	103	103		103			
Adapter 3/8 inch <input type="checkbox"/> x 1/4 inch <input checked="" type="checkbox"/>	104		204			104			204			
Adapter 3/8 inch <input type="checkbox"/> x 1/2 inch <input checked="" type="checkbox"/>	105		205			105			205			
FixGRIP-Adapter 3/8 inch <input type="checkbox"/> x 1/2 inch <input checked="" type="checkbox"/>						106						

51308 - 51314 Extensions **3/8"**

Type
Chrome-plated, drop-forged.

51308
ATORN®
Chrome-vanadium steel.

51309
GEDORE
Vanadium 31CrV3.

51310
STAHWILLE
Chrome alloy steel.

51312
HAZET
Chrome-vanadium steel.

51312 201
HAZET
Flexible extension
Burnished shaft.

51314
STAHWILLE
With QuickRelease safety lock.
Chrome alloy steel.

	ATORN®		GEDORE		STAHWILLE		HAZET		STAHWILLE	
Length mm	51308	...	51309	...	51310	...	51312	...	51314	...
36									101	
50	100									
75	101		101		102		102		101	
125	103		102		103		103			
150	104						104			
160									102	
180			110							
202							105			
210							201			
240					105				103	
250	105		103				106			
304							107			
508							108			
711							109			



Hand Tools

51315 Swivelling extensions **3/8"**

HAZET
Type
Chrome-plated, polished.

Use
With ball-type, conical outer square. Allows a flex angle to any side of 8°.

Quality
Chrome-vanadium steel.

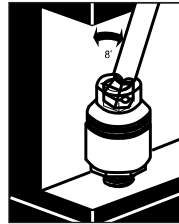

Overall length mm	51315	...
36		201
74		202
254		203

51316 Cardan extensions **3/8"**

GEDORE
Type
With ball lock.

Use
The extension allows a turning of 15°.

Length mm	51316	...
76		101
125		102
250		103



When you receive quality ...

... then it's ATORN.

ATORN®

Performance requires quality

www.atorn.de

51318

Open-end double hexagon ring wrench (crowfoot wrenches)

3/8"



Type

Chrome-plated, with inside square drive.

Use

Especially for working in hard-to-reach places.

Quality

Chrome-vanadium steel.

51318



AF mm	51318	...
16	101	
17	102	
18	103	
19	104	

AF mm	51318	...
21	105	
22	106	
24	107	
27	109	

51319

Adjustable wrenches (crowfoot wrenches)

3/8"



Type

- Opening width adjustable up to 29 mm (1.1/8 inch)
- Adjustment of the jaw width by simple movement of the lateral adjusting nut
- Lasered measuring scale in mm and inch

- Significantly exceeds the torque requirements for 3/8 inch turning tools and adjustable wrenches with the identical opening sizes
- ISO 1174 and DIN 3120
- Chrome-plated and highly polished, high-quality surface

Quality

High-performance ferrous alloy.

51319



Clamping width mm	Clamping width Inch	51319	...
29	1.1/8	#	101

51320

Hexagonal socket wrench set

1/2"



51320



Type

In sheet steel case with foam-material inlay.
All tools are stored vibration-free.

Quality

Chrome-vanadium steel.

Set contents	Type	51320	...
19-piece in sheet steel case			101

Set contents	
14	Hexagonal inserts with energy profile AF 10 / 11 / 12 / 13 / 14 / 15 / 16 / 17 / 19 / 22 / 24 / 27 / 30 / 32 mm
1	Reversible ratchet
1	Handle with sliding piece
1	Universal joint
2	Extensions 125 / 250 mm



51321

Hexagonal socket wrench set

1/2"



51321



Type

In sheet steel case with foam-material inlay.
All tools are stored vibration-free.

Quality

Chrome-vanadium steel.

Set contents	Type	51321	...
22-piece in sheet steel case			101

Set contents	
15	Hexagonal inserts with energy profile AF 10 / 11 / 12 / 13 / 14 / 15 / 16 / 17 / 18 / 19 / 22 / 24 / 27 / 30 / 32 mm
2	Hexagonal inserts with energy profile for spark plugs AF 16 / 21 mm
1	Reversible ratchet
1	Universal joint
1	Adapter 1/2 x 3/8 inch
2	Extensions 125 / 250 mm



51328

Hexagonal socket wrench set

1/2"



51328



Type

- Forged, tempered, hand-operated hexagonal UD profile socket wrench inserts
- Robust lever reversible ratchet with Push-button release
- In GEDORIT blue sheet steel case (290 x 132 x 55 mm)

Quality

Accessories from GEDORE vanadium steel 31CrV3.

Set contents	Type	51328	...
13-piece in sheet steel case			201

Set contents	
11	Inserts with UD profile AF 10 / 12 / 13 / 14 / 15 / 16 / 17 / 18 / 19 / 22 / 24 mm
1	Reversible ratchet
1	Extension 125 mm



Socket Wrenches Sets

51341

Hexagonal socket set

1/2"



Type
With Quick-Release system
(one-hand safety lock).

Quality
Chrome alloy steel.

51341



Set contents	
16	Inserts with AS-drive profile AF 10 / 11 / 12 / 13 / 14 / 15 / 16 / 17 / 18 / 19 / 21 / 22 / 24 / 27 / 30 / 32 mm
1	Reversible ratchet
1	Handle with sliding piece
1	Universal joint
3	Extensions 75 / 130 / 255 mm

Set contents	Type	51341	...
22-piece	in plastic case		201

51336 - 51337

Hexagonal and double hexagonal socket wrench sets

1/2"



Type
Chrome-plated.
Quality
Chrome alloy steel.



51336 104



51337 104



Set contents 51336 104 + 51337 104	
12	Inserts with AS-drive profile AF 10 / 13 / 16 / 17 / 18 / 19 / 21 / 22 / 24 / 27 / 30 / 32 mm
1	Reversible ratchet
2	Extensions 130 / 255 mm



51337 107



Set contents 51337 107	
16	Inserts with AS-drive profile AF 10 / 11 / 12 / 13 / 14 / 15 / 16 / 17 / 18 / 19 / 21 / 22 / 24 / 27 / 30 / 32 mm
1	Reversible ratchet
1	Handle with sliding piece
1	Universal joint
3	Extensions 75 / 130 / 255 mm



51336 109



51337 109



Set contents 51336 109 + 51337 109	
22	Inserts with AS-drive profile AF 8 / 9 / 10 / 11 / 12 / 13 / 14 / 15 / 16 / 17 / 18 / 19 / 20 / 21 / 22 / 23 / 24 / 26 / 27 / 28 / 30 / 32 mm
1	Reversible ratchet
1	Handle with sliding piece
1	Universal joint
3	Extension 75 / 130 / 255 mm

Set contents	Type	Hexagonal		double Hexagon	
		51336	...	51337	...
15-piece	in sheet steel case			104	104
22-piece	in sheet steel case			107	107
28-piece	in sheet steel case			109	109

51338 - 51339

Hexagonal and double hexagonal socket wrench set

1/2"



Quality
Chrome-vanadium steel.



51338



51339

Set contents				
20	Inserts with traction profile	AF 10 / 11 / 12 / 13 / 14 / 15 / 16 / 17 / 18 / 19 / 20 / 21 / 22 / 23 / 24 / 26 / 27 / 28 / 30 / 32 mm		
1	Reversible ratchet			
1	Handle with sliding piece			
1	Universal joint			
2	Extensions 123 / 248 mm			
Set contents	Type	Hexagonal	double Hexagon	...
25-piece	in SmartCase	101	101	



51342

Hexagonal socket wrench set

1/2"



OGV®



Type
With safety lock.

Quality
Chrome-vanadium steel.

Set contents				
17	Hexagonal inserts with OGV® profile	AF 10 / 11 / 12 / 13 / 14 / 15 / 16 / 17 / 18 / 19 / 21 / 22 / 23 / 24 / 27 / 30 / 32 mm		
1	Reversible ratchet			
1	Universal joint			
2	Extensions 125 / 250 mm			
Set contents	Type	51342	...	
21-piece	in plastic case	201		



51345

Hexagonal socket wrench set

1/2"



OGV®



Quality
Chrome-vanadium steel.

Set contents				
17	Hexagonal inserts with OGV® profile	AF 10 / 11 / 12 / 13 / 14 / 15 / 16 / 17 / 18 / 19 / 21 / 22 / 23 / 24 / 27 / 30 / 32 mm		
1	Reversible ratchet			
1	Universal joint			
2	Extensions 125 / 250 mm			
Set contents	Type	51345	...	
21-piece	in plastic case	101		



51348

Hexagonal socket wrench set

1/2"



Type
All tools are stored vibration-free.

Quality
Chrome-vanadium steel.

Set contents				
18	Hexagonal inserts with energy profile	AF 10 / 11 / 12 / 13 / 14 / 15 / 16 / 17 / 18 / 19 / 20 / 21 / 22 / 23 / 24 / 27 / 30 / 32 mm		
5	Inserts for hexagon socket head screws AF 7 / 8 / 10 / 12 / 14 mm			
2	Inserts for Phillips recess head screws PH 3 / 4			
5	Inserts for inner TORX® screws T 30 / 40 / 45 / 55 / 60			
1	Adapter 3/8 inch x 1/2 inch			
1	Reversible ratchet			
1	Universal joint			
2	Extensions 125 / 250 mm			
Set contents	Type	51348	...	
35-piece	in sheet steel case with foam-material inlay	101		



Socket Wrenches Sets

51349

Hexagonal socket wrench sets

1/4"

1/2"



ATORN®

Quality
Chrome-vanadium steel.

51349

Type
All tools are stored vibration-free.



Spalte 2	Set contents
1/4" ○	5 Hexagonal inserts with energy profile AF 5.5 / 7 / 8 / 10 / 13 mm
●	3 Inserts for hexagon socket head screws AF 3 / 4 / 5 mm
Each with 1 Reversible ratchet, handle with sliding piece, universal joint	
2 Extensions 50 / 105 mm	
1/2" ○	11 Hexagonal inserts with energy profile AF 10 / 13 / 16 / 17 / 18 / 19 / 22 / 24 / 27 / 30 / 32 mm
●	6 Inserts for hexagon socket head screws AF 6 / 8 / 10 / 12 / 14 / 17 mm
Each with 1 Reversible ratchet, handle with sliding piece, universal joint	
2 Extensions 125 / 250 mm	
Set contents	Type 51349 ...
35-piece	in sheet steel case with foam-material inlay 201

51357

Socket wrench set

1/4"

1/2"



Use
For opening hexagonal, double hexagon, imperial and E-TX profiles.

Quality
Chrome-vanadium steel.

51357



Set contents	Set contents
1/4" 13 Inserts AF 4 / 4.5 / 5 / 5.5 / 6 / 7 / 8 / 9 / 10 / 11 / 12 / 13 / 14 mm	1/2" 18 Inserts AF 10 / 11 / 12 / 13 / 14 / 15 / 16 / 17 / 18 / 19 / 20 / 21 / 22 / 23 / 24 / 27 / 30 / 32 mm
● 4 Bits for hexagon socket head screws AF 3 / 4 / 5 / 6 mm	○ 2 Spark plugs inserts AF 16 / 21 mm
⊖ 3 Bits for slotted screws 4 / 5.5 / 7 mm	1 Reversible ratchet
⊕ 2 Bits for Phillips recess head screws PH 1 / 2	1 Universal joint
⊕ 2 Bits for Phillips recess head screws PZ 1 / 2	2 Extensions 125 / 250 mm
⊗ 6 Bits for TORX® screws T 8 / 10 / 15 / 20 / 25 / 30	1 Adapter 1/2 inch x 8 mm / bit adapter
1 Reversible ratchet	1 Sliding T-handle adapter 3/8 inner x 1/2 outer
1 Handle with sliding piece	○ Bits with bit adapter 8 mm:
1 Driver with plastic grip	⊖ 3 Bits for slotted screws 8 / 10 / 12 mm
1 Universal joint	⊕ 2 Bits for Phillips recess head screws PH 3 / 4
1 Flexible extension 150 mm	⊕ 2 Bits for Phillips recess head screws PZ 3 / 4
2 Extensions 50 / 100 mm	⊗ 4 Bits for TORX® screws T 40 / 45 / 50 / 55
1 Adapter outer square x outer hexagon	4 Bits for hexagon socket head screws AF 8 / 10 / 12 / 14 mm
Set contents	Type 51357 ...
82-piece	in aluminium case with removable tool insert 101

51351

Hexagonal socket wrench set

1/4"

1/2"



STAHLWILLE®

Quality
Chrome alloy steel.

51351

Type
Chrome-plated.



Set contents	Set contents
1/4" ○ 9 Hexagonal inserts with AS-drive profile AF 4 / 5 / 5.5 / 6 / 7 / 8 / 9 / 10 / 11 mm	1/2" ○ 10 Hexagonal inserts with AS-drive profile AF 13 / 16 / 17 / 18 / 19 / 21 / 22 / 24 / 27 / 30 mm
● 3 Inserts for hexagon socket head screws AF 3 / 4 / 5 mm	● 5 Inserts for hexagon socket head screws AF 6 / 8 / 10 / 12 / 14 mm
1 Reversible ratchet	1 Reversible ratchet
1 Driver with plastic grip	1 Handle with sliding piece
1 Handle with sliding piece	2 Extensions 130 / 255 mm
2 Extensions	1 Universal joint
1 Universal joint	1 Reversible ratchet with switching lever
Set contents	Type 51351 ...
38-piece	in sheet steel case 101

51352

Hexagonal socket wrench set

1/4"

1/2"

**GEDORE**Quality
Vanadium 31CrV3.

51352

Type

With forged, tempered hexagonal UD inserts and accessories.

Set contents	
1/4" ○ 11	Hexagonal inserts with UD profile AF 4 / 4.5 / 5 / 5.5 / 6 / 7 / 8 / 9 / 10 / 11 / 13 mm
● 4	Inserts for hexagon socket head screws AF 3 / 4 / 5 / 6 mm
⊖ 3	Inserts for slotted screws 0.8 x 4 / 1.0 x 5.5 / 1.2 x 6.5 mm
⊕ 2	Inserts for Phillips recess head screws PH 1 / 2
2	Extensions 55 / 97 mm
1	Universal joint
1	Handle with sliding piece
1	Driver with plastic grip
1	Reversible ratchet with switching lever

1/2" ○ 12	Hexagonal inserts with UD profile AF 10 / 11 / 12 / 13 / 14 / 15 / 17 / 19 / 22 / 24 / 27 / 30 mm
● 5	Inserts for hexagon socket head screws AF 7 / 8 / 10 / 12 / 14 mm
⊖ 2	Inserts for slotted screws 1.2 x 8 / 1.6 x 10 mm
⊕ 1	Insert for Phillips recess head screws
2	Extensions 125 / 250 mm
1	Universal joint
1	Reversible ratchet with switching lever



Set contents	Type	51352	...
50-piece	in sheet steel case		101

51353 - 51354

Hexagonal and double hexagonal socket wrench sets

1/2"

**STAHLWILLE**

Type

Chrome-plated.

Quality

Chrome alloy steel.



51353 102



51354 201



Set contents 51353 102 + 51354 201	
17	Inserts with AS-drive profile AF 8 / 10 / 11 / 12 / 13 / 14 / 15 / 16 / 17 / 18 / 19 / 21 / 22 / 24 / 27 / 30 / 32 mm
● 8	Inserts for hexagon socket head screws AF 4 / 5 / 6 / 7 / 8 / 10 / 12 / 14 mm
Each with 1 reversible ratchet, handle with sliding piece, universal joint	
3	Extensions 75 / 130 / 255 mm

Set contents 51353 110 + 51354 110	
19	Inserts with AS-drive profile AF 8 / 9 / 10 / 11 / 12 / 13 / 14 / 15 / 16 / 17 / 18 / 19 / 21 / 22 / 24 / 27 / 30 / 32 / 34 mm
○ 2	Double hexagonal inserts with AS-drive profile AF 20.8 mm-13/16 inch and 16 mm-5/8 inch with rubber insert for spark plugs
● 7	Inserts for hexagon socket head screws AF 4 / 5 / 6 / 7 / 8 / 10 / 12 mm
13	Combination wrench AF 10 / 11 / 12 / 13 / 14 / 15 / 16 / 17 / 18 / 19 / 21 / 22 / 24 mm
Each with 1 reversible ratchet, handle with sliding piece, 1 universal joint	
3	Extensions 75 / 130 / and 255 mm

Set contents	Type	Hexagonal 51353	...	double Hexagon 51354	...
31-piece	in sheet steel case with TCS insert			102	201
47-piece	in sheet steel case	#		110	# 110



51353 110



51354 110



51355

Hexagonal socket wrench set

1/2"

**HAZET**Quality
Chrome-vanadium steel.

51355

Set contents	
Ⓣ 18	Hexagonal inserts with traction profile AF 10 / 11 / 12 / 13 / 14 / 15 / 17 / 19 / 20 / 21 / 22 / 23 / 24 / 26 / 27 / 28 / 30 / 32 mm
● 7	Inserts for hexagon socket head screws AF 5 / 6 / 7 / 8 / 10 / 12 / 14 mm
⊕ 4	Bits for Phillips recess head screws PH 1 / 2 / 3 / 4
⊕ 4	Bits for Phillips recess head screws PZ 1 / 2 / 3 / 4
⊕ 5	Inserts for inner TORX® screws T 27 / 30 / 40 / 45 / 50
Each with 1 connection part for bits 1/4 inch, reversible ratchet, handle with sliding piece, universal joint	
2	Extensions 123 / 248 mm

Set contents	Type	51355	...
44-piece	in plastic case		101



51358

Hexagonal socket wrench sets

1/4"

1/2"



carolus

Type

With lever reversible ratchet, finely toothed (72 teeth), with 2-component handle.

51358

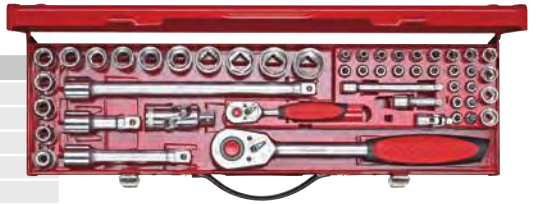

Set contents	
1/4"	1 Reversible ratchet with 2-component handle
○	12 Hexagonal inserts AF 4 / 4.5 / 5 / 5.5 / 6 / 7 / 8 / 9 / 10 / 11 / 12 / 13 mm
⊛	7 Inserts TORX® with bore TX 10 / 15 / 20 / 25 / 27 / 30 / 40
⬢	4 Inserts for hexagon socket head screws AF 4 / 5 / 6 / 8 mm
⊖	1 Insert for slotted screws 5.5 mm
⊕	1 Insert for Phillips recess head screws PH 2
⊕	1 Insert for Phillips recess head screws PZ 2
Each with 1	Extension 50 / 100 mm, universal joint
1/2"	1 Ratchet with 2-component handle
○	13 Hexagonal inserts AF 10 / 11 / 12 / 13 / 14 / 15 / 16 / 17 / 18 / 19 / 21 / 22 / 24 mm
Each with 1	Extension 75 / 125 / 250 mm, universal joint
1	Adapter 1/2 inch ■ x 5/16 inch ●, also for use with AF 8 mm

Set contents	Type	51358	...
49-piece	in all-steel box		301

51359

Hexagonal socket wrench sets

1/4"

1/2"

5/16"



BAHCO

Quality

Chrome-vanadium.

Type

Matt chrome-plated, with Dynamic-Drive profile. Plastic case made of impact-proof, oil and temperature-resistant polyethylene (HDPE), 375 x 320 x 110 mm.

51359



Set contents	
1/4"	12 Hexagonal inserts with Dynamic-Drive profile AF 4 / 4.5 / 5 / 5.5 / 6 / 7 / 8 / 9 / 10 / 11 / 12 / 13 mm
○	10 Long hexagonal inserts with Dynamic-Drive profile AF 4 / 5 / 6 / 7 / 8 / 9 / 10 / 11 / 12 / 13 mm
⬢	6 Bits for hexagon socket head screws AF 3 / 4 / 5 / 6 / 8 / 10 mm
⊖	3 Bits for slotted screws 4 / 5.5 / 7 mm
⊕	5 Bits for Phillips recess head screws PH size 0 / 1 / 2 / 3 / 4
⊕	3 Bits for Phillips recess head screws PZ size 1 / 2 / 3
⊛	8 Bits for TORX® screws T 8 / 10 / 15 / 20 / 25 / 27 / 30 / 40
Each with 1	Reversible ratchet 60 teeth, sliding T-handle (T-handle) 105 mm, driver
Each with 1	Universal joint, extension 50 / 100 mm
Each with 1	Magnetic holder, connection part 1/4 inch, bit holder
1/2"	13 Hexagonal inserts with Dynamic-Drive profile AF 10 / 11 / 12 / 13 / 14 / 15 / 17 / 19 / 22 / 24 / 27 / 30 / 32 mm
○	1 Spark plug socket wrench insert AF 21 mm (13/16 inch)
Each with 1	Reversible ratchet 60 teeth, universal joint, sliding T-adapter
Each with 1	Extension 125 / 250 mm, bit holder 5/16 inch mount.
3/8"	3 Bits for TORX® screws T 45 / 50 / 55
⬢	6 Combination wrench AF 8 / 10 / 12 / 13 / 14 / 17 mm
⬢	4 Flex head socket wrench AF 8x9 / 10x11 / 12x13 / 14x15 mm
⬢	3 Offset screwdrivers for hexagonal socket AF 1.5 / 2 / 2.5 mm

Set contents	Type	51359	...
92-piece	in plastic case		201

51361

Tool Set -Touring 1000-

1/2"



GEDORE

Quality

Chrome-vanadium steel.

Type

In handy plastic case with practical hinged handle. The case is impact-proof, resistant against oil and acids, resistant against environmental influences. The tools sit tight in the case, therefore no rattling. Outer dimensions: 435 x 345 x 135 mm.

51361



Set contents	
○	9 Hexagonal inserts with UD profile AF 10 / 11 / 12 / 13 / 14 / 15 / 17 / 19 / 22 mm
1	Spark plug insert with magnet AF 20.8 / AF 13/16
1	Reversible ratchet with switching lever 270 mm
1	Handle with sliding piece 290 mm
1	Universal joint 70 mm
2	Extensions 125 / 250 mm
11	Combination wrenches AF 6 / 7 / 8 / 10 / 11 / 12 / 13 / 14 / 15 / 17 / 19 mm (UD profile)
8	Allen keys in holder AF 2 / 2.5 / 3 / 4 / 5 / 6 / 8 / 10 mm
⊖	3 Slotted screwdriver 0.8 x 4.0 / 1.0 x 5.5 / 1.2 x 6.5 mm
⊖	1 Slotted screwdriver for set screws with slot 0.5 x 3.0 mm
⊕	2 Phillips screwdrivers PH 1 x 80 / 2 x 100 mm
1	Waterpump pliers 245 mm
1	Combination pliers 180 mm
1	Diagonal cutting pliers 160 mm
⊖	1 Mains tester screwdriver
1	Folding knife
1	Small-parts tin
1	Machinist's hammer 300 g

Set contents	Type	51361	...
47-piece	in plastic case		101

51374

Bit rails, magnetic (empty)

1/2"



51374



Type

Outer square suitable for socket wrench bits nominal size 12.5 (1/2 inch). **2 additional inner square wrench adapters for ratchets, sliding handles, extension pieces, etc.** A strong magnet allows for a secure fastening of the rail to metal objects. Additional boreholes allow the fastening to non-metallic objects and walls.

The bits are held securely by the ball by means of turning them 90°.

Turning them 90° in the opposite direction will release the bits so that they can be removed.

Tools not included.

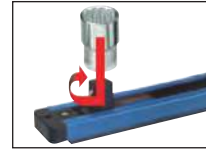

for inserts pcs.	Length mm	Width mm	Weight g	51374	...
12	480	33	470		100
16	580	33	550		101

51375 - 51379

Hexagonal Socket Wrench Sockets DIN 3124/ISO 2725

1/2"



Type

Chrome-plated, drop-forged.

Quality

Chrome-vanadium steel.

51375



With Energy profile.

51377



With UD profile.

Quality

31 Cr V3.

51378



With AS-drive profile.

Quality

HPQ heavy-duty steel.

51379



With Tractions profile.

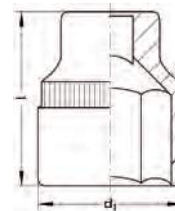

51375



51377



51378



51379



AF mm	l approx. mm	d ₁ approx. mm	ATORN®		GEDORE		STAHLWILLE		HAZET	
			51375	...	51377	...	51378	...	51379	...
8	36	13.0		201			#	101		101
9	36	14.0		202				102	#	102
10	38	15.0		203		103		103		103
11	38	16.5		204		104	#	104		104
12	38	18.0		205		105		105		105
13	38	19.0		206		106		106		106
14	38	20.5		207		107		107		107
15	38	21.5		208		108		108		108
16	38	22.5		209		109		109		109
17	38	24.0		210		110		110		110
18	38	25.5		211		111		111		111
19	38	26.5		212		112		112		112
20	38	28.0		213		113		113		113
21	38	29.0		214		114		114		114
22	41	30.5		215		115		115		115
23	41	31.5		216		116	#	116		116
24	41	33.0		217		117		117		117
25	41	34.0				118				118
26	41	35.5		219		119				119
27	44	36.5		220		120				120
28	44	38.0		221		121				121
29	44	39.0								122
30	44	40.5		223		123				123
32	45	42.5		225		125				125
34	45	45.5				126				126
36	44.5	48.0				127				



Hand Tools

Socket wrench inserts | Screwdriver inserts

51394 - 51396

Double hexagonal socket wrench inserts DIN 3124/ISO 2725

1/2" 

Type
Chrome-plated, drop-forged.

51394

With UD profile.
Quality
31 Cr V3.

51395

With AS-drive profile.
Quality
HPQ heavy-duty steel.

51396

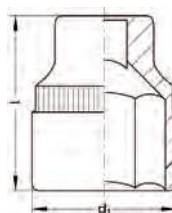
With Tractions profile.
Quality
Chrome-vanadium steel.



51394





51395



51396



AF	I	d ₁		...		...		...
mm	approx. mm	approx. mm	51394		51395		51396	
8	38.0	13.0			101			
9	38.0	14.0			102			
10	38.0	15.5	103		103		103	
11	38.0	16.5	104		104	#	104	
12	38.0	18.0	105	#	105		105	
13	38.0	19.0	106				106	
14	38.0	20.5	107		107		107	
15	38.0	21.5	108		108		108	
16	38.0	22.5	109		109		109	
17	38.0	24.0	110		110		110	
18	38.0	25.5	111		111		111	
19	38.0	26.5	112		112		112	

AF	I	d ₁		...		...		...
mm	approx. mm	approx. mm	51394		51395		51396	
20	38.0	28.0			#		113	#
21	38.0	29.0			114		114	
22	41.5	30.5			115		115	
23	41.5	31.5						116
24	41.5	33.0			117		117	
25	41.5	34.0						118
26	41.5	35.5						119
27	44.0	36.5			120		120	
28	44.0	38.0					#	121
30	44.0	40.5			123		123	
32	44.0	42.5			125		125	
34	44.0	45.0					126	

51401 - 51405

Long double hexagonal socket Wrench inserts DIN 3124/ISO 2725

1/2" 

Type
Long, chrome-plated, drop-forged and polished.
Use
For deeply set screws and protruding bolts.
Quality
Chrome-vanadium steel.

51401

With Energy profile.

Note:
End no. 112 Hexagonal spark plug inserts with rubber insert for spark plugs.

51402

With UD profile.

51403

With AS-drive profile.
Quality
HPQ heavy-duty steel.

51405

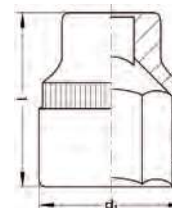
With Tractions profile.
Note:
End no. 109 with rubber insert for spark plugs.



51401



51402







51403



51405



AF	I	d ₁		...		...		...		...
mm	mm	approx. mm	51401		51402		51403		51405	
10	82	15.5			101		101			101
11	82	16.5			102					
12	82	17.5			103					102
13	82	19.0			104		103		103	103
14	82	20.0			105	#	104		104	104
15	82	21.5			106					
16	82	23.0			107		105		106	105
17	82	24.0			108		106		108	106
18	82	24.5			109		107		109	107
19	82	27.0			110		108		110	108
20	82	28.0			111					
20.8	82	28.5								109
21	65	27.7			112					
21	82	28.5			113	#	110		113	110
22	82	30.0			114		111		114	111
23	82	31.5			115					
24	82	32.5			116		112		115	112
26	82	35.0		#	117					
27	82	36.5			118		113		117	113
30	82	40.0			119		114		119	114
32	82	43.0			120		115		120	
34	82	45.0					116			

51409

Double hexagonal socket wrench inserts (inch) DIN 3124/ISO 2725

1/2"



51409



Quality
Chromo-Extra.

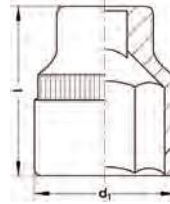

Type
Imperial sizes. With Dynamic-Drive profile.
Nickel-plated and chrome-plated, highly polished.

AF inch	l mm	d ₁ mm	51409	...
3/8	38	14.5		101
7/16	38	16.6		102
1/2	38	18.8		103
9/16	38	20.8		104
19/32	38	21.6		105
5/8	38	22.9		106
11/16	38	24.7		107
3/4	38	26.6		108
25/32	38	27.9	#	109

AF inch	l mm	d ₁ mm	51409	...
13/16	39	28.7		110
7/8	39	30.7		111
15/16	41	32.7		112
1.	42	34.7		113
1.1/16	44	36.6	#	114
1.1/8	46	38.6		115
1.3/16	47	40.4	#	116
1.1/4	47	42.3	#	117

51410

Screwdriver inserts

1/2"

ATORN[®]

Type
Chrome-plated, blades burnished.
Quality
Vanadium special steel.

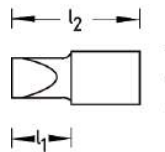

Blade thickness x width mm	Size PH	Size PZ	l ₁ approx. mm	l ₂ approx. mm	d approx. mm	51410	...
⊖ 1.2 x 8			22	60	22.5		102
⊖ 1.6 x 10			22	60	22.5		104
⊖ 2.0 x 12			22	60	22.5		105
⊖ 2.5 x 14			20	60	22.5	#	106
	⊕ PH 2		22	60	22.5	#	201
	⊕ PH 3		22	60	22.5	#	202
	⊕ PH 4		22	60	22.5	#	203
		⊕ PZ 2	22	60	22.5	#	301
		⊕ PZ 3	22	60	22.5	#	302
		⊕ PZ 4	22	60	22.5	#	303

51414

Hexagonal screwdriver set

1/2"



51414

ATORN[®]

Type
All tools are stored vibration-free.
Quality
Chrome-vanadium steel.

Set contents	
9	Inserts for hexagon socket head screws AF 5 / 6 / 7 / 8 / 9 / 10 / 12 / 14 / 17 mm
Set contents	Type
9-piece	in sheet steel case with foam-material inlay

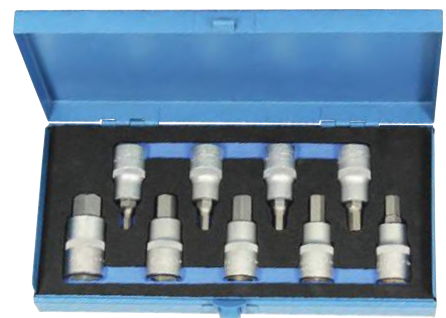

51415 - 51416

Hexagonal screwdriver sets

1/2"



51415

GEDORE

Quality
Vanadium special steel.

Cat.-no.	Set contents		
51415 101	9	AF 5 / 6 / 7 / 8 / 9 / 10 / 12 / 14 / 17 mm	
51416 101	9	AF 3/16 / 7/32 / 1/4 / 9/32 / 5/16 / 3/8 / 1/2 / 9/16 / 5/8 inch	
Set contents	Type	mm	inch
9-piece		51415	51416



Screwdriver inserts

51419 Hexagonal screwdriver set 1/2"



Type
All tools are stored vibration-free.
Quality
Chrome-vanadium steel.

Set contents			
	9	Inserts for hexagon socket head screws AF 5 / 6 / 7 / 8 / 9 / 10 / 12 / 14 / 17 mm	
	1	Lever reversible ratchet with 2-component handle 255 mm	
	1	Extension 250 mm	

Set contents	Type	51419	...
11-piece	in sheet steel case with foam-material inlay		101



51420 Hexagonal screwdriver set 1/2"



Quality
Chrome-vanadium steel.

Set contents			
	8	Inserts AF 5 / 6 / 8 / 10 / 12 / 14 / 17 / 19 mm	
	1	Reversible ratchet	
	1	Handle with sliding piece	
	2	Extensions 123 / 248 mm	

Set contents	Type	51420	...
12-piece	in metal case		101



51424 - 51428 Hexagonal screwdriver inserts 1/2"

Type
Chrome-plated, drop-forged.
Quality
Chrome-vanadium steel.



51426

51427
Quality
Chrome alloy steel.

51428
Blade CVD-TiN coated.

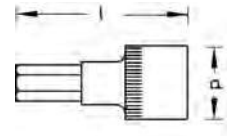

AF	L	L	L	L	d	51424	...	51426	...	51427	...	51428	...
mm	mm	mm	mm	mm	approx. mm								
4	57	-	60	60	22.5	101				101		101	
5	57	60	60	60	22.5	102		102		102		102	
L 5	-	180	120	180	22.5			104		104		104	
6	57	60	60	60	22.5	105		105		105		105	
L 6	-	140	120	137	22.5			107		107		107	
7	57	60	60	60	22.5	109		109		109		109	
L 7	-	-	120	100	22.5					110		110	
8	57	60	60	60	22.5	111		111		111		111	
L 8	-	120	120	119	22.5			113		113		113	
10	57	60	60	60	23.0	115		115		115		115	
L 10	-	140	140	141	23.0			116		116		116	
12	57	60	60	60	23.5	118		118		118		118	
L 12	-	-	140	-	23.5					119			
14	57	60	60	60	25.0	120		120		120		120	
L 14	-	-	140	-	23.5					121			
17	57	60	60	60	28.0	122		122		122		122	
19	57	60	60	60	30.0	124		123		123		123	

51431 - 51432

Long hexagonal-ball head screwdrivers-socket wrench inserts



51431



Type

With ball-retaining groove and non-slip knurling. Sleeve chrome-plated, burnished blade.

Use

Total flex angle approx. 15-20°.

Quality

Pointed tip made of vanadium special steel.

51432



Type

Sleeve chrome-plated, blade CVD-TiN coated.

Use

For operation in hard-to-reach areas, flex angle 25°.

Quality

Chrome-vanadium steel, special steel blade.

51431



51432

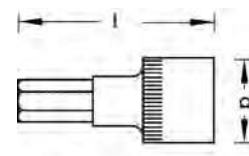

AF mm	l mm	GEDORE		HAZET	
		51431	...	51432	...
5	140				101
6	140		101		102
7	140		102		103
8	140		103		104
10	140		104		105
12	140		105		106

51436 - 51437

TORX® screwdriver sets



Use

For inner TORX® screws.

Quality

Vanadium special steel.

Note:

Torx® selector see cat.-no. 37930.

51436



51437



Cat.-no.	Set contents
51436 101	9 short type (55 mm): T 20 / 25 / 27 / 30 / 40 / 45 / 50 / 55 / 60
51437 101	18 Each with 1 x short (55 mm) and long (100 mm) type: T 20 / 25 / 27 / 30 / 40 / 45 / 50 / 55 / 60

Set contents	Type	51436	...	51437	...
9-piece	in sheet steel case		101		
18-piece	in sheet steel case			101	

51441

TORX® screwdriver set



Type

In SmartCase 185 x 153 x 52 mm. In safety insert system, 2-component soft foam-material inlay.

Use

For inner TORX® screws.

Quality

Chrome-vanadium steel.

Note:

Torx® selector see cat.-no. 37930.

51441



Set contents
3 Inserts 1/4 inch T 8 / T 10 / T 15
3 Inserts 3/8 inch T 20 / T 25 / T 30
4 Inserts 1/2 inch T 40 / T 50 / T 55 / T 60

Set contents	Type	51441	...
10-piece	in SmartCase		101

Screwdriver inserts | Torx® sets

51444 - 51447

TORX® screwdriver inserts

1/2"



Type
Chrome-plated, drop-forged, blades burnished.
Use
For inner TORX® screws.
Quality
Chrome-vanadium steel.

51444
ATORN®



51444

Note:
TORX® selector, see cat. no. 37930.

51445
GEDORE

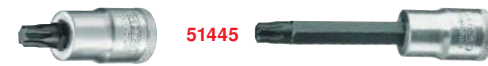

51445

51446
STAHLWILLE
Quality
Chrome alloy steel.



51446

51447
HAZET
CVD-TiN-coated blade.



51447

Size T	l approx. mm	d approx. mm	ATORN®		GEDORE		STAHLWILLE		HAZET	
			51444	...	51445	...	51446	...	51447	...
20	55	23		101		101	#	101		101
L 20	100	23	#	102	#	102				
25	55	23		103		103	#	103		103
L 25	100	23		104		104				
27	55	23		105		105	#	105		105
L 27	100	23	#	106		106				
30	55	23		107		107		107		107
L 30	100	23	#	108		108				
40	55	23		109		109		109		109
L 40	100	23		110		110				
45	55	23		111		111		111		111
L 45	100	23		112		112				
50	55	23		113		113		113		113
L 50	100	23		114		114				
55	55	24.6		115		115		115		115
L 55	100	23		116		116				
60	55	24.6		117		117	#	117		117
L 60	100	23		118	#	118				
70	60	25.7						119		

51451

ResisTORX® screwdriver inserts

1/2"



Type
Sleeve chrome-plated, blade CVD-TiN coated.
Use
For inner TORX® screws with pin.

Quality
Chrome-vanadium steel, special steel blade.

Note:
TORX® selector, see cat. no. 37930.



51451

Size T	l mm	d mm	51451	...
30	55	23	#	101
40	55	23		102
45	55	23		103
50	55	23		104
55	56	23	#	105

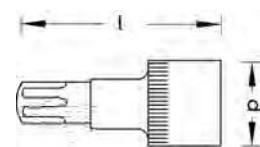

51450

TORX® set

1/2"



Type
All tools are stored vibration-free.

Quality
Chrome-vanadium steel.

51450

Note:
Torx® selector see cat.-no. 37930.

Set contents	Type	51450	...
9 Inserts for inner TORX® screws T 20 / 25 / 27 / 30 / 40 / 45 / 50 / 55 / 60			
9 Inserts for outer TORX® screws E 10 / 11 / 12 / 14 / 16 / 18 / 20 / 22 / 24			
1 Lever reversible ratchet with 2-component handle 255 mm			
2 Extensions 125 / 250 mm			
Set contents			
21-piece	in sheet steel case with foam-material inlay		101



51452

TORX® set

1/4"

1/2"

**GEDORE**

Use

For inner and outer TORX® screws.

Quality

Vanadium 31CrV3.

Note:

Torx® selector see cat.-no. 37930.



51452

Set contents

1/4"	8	Inserts for inner TORX® screws T8 / 9 / 10 / 15 / 20 / 25 / 27 / 30
	6	Inserts for outer TORX® screws E4 / 5 / 6 / 7 / 8 / 10
1/2"	5	Inserts for inner TORX® screws short T40 / 45 / 50 / 55 / 60
	9	Inserts for inner TORX® screws long T20 / 25 / 27 / 30 / 40 / 45 / 50 / 55 / 60
	6	Inserts for outer TORX® screws E12 / 14 / 16 / 18 / 20 / 24

Set contents	Type	51452	...
34-piece	in sheet steel case		101

51455

TORX® set

1/2"

**GEDORE**

Use

For inner and outer TORX® screws.

Quality

Vanadium 31CrV3.

Note:

Torx® selector see cat.-no. 37930.



51455

Set contents

	9	Inserts for inner TORX® screws T20 / 25 / 27 / 30 / 40 / 45 / 50 / 55 / 60
	8	Inserts for outer TORX® screws E10 / 11 / 12 / 14 / 16 / 18 / 20 / 24

Set contents	Type	51455	...
17-piece	in sheet steel case		301

51457

TORX® socket wrench set

1/4"

3/8"

1/2"

**STAHLWILLE**

Type

Chrome-plated.

Quality

Chrome alloy steel.

Note:

Torx® selector see cat.-no. 37930.



51457

Set contents

1/4"	2	Inserts for inner TORX® screws T8 / 9
	3	Inserts for outer TORX® screws E4 / 5 / 6
	7	Bits TORX® with bore T10 / 15 / 20 / 25 / 27 / 30 / 40
3/8"	5	Inserts for inner TORX® screws T10 / 15 / 20 / 25 / 27
	4	Inserts for outer TORX® screws E7 / 8 / 10 / 12
	1	Bit holder with hexagonal socket 1/4 inch
1/2"	6	Inserts for inner TORX® screws T30 / 40 / 45 / 50 / 55 / 60
	6	Inserts for outer TORX® screws E11 / 14 / 16 / 18 / 20 / 24
	1	TORX® selector for inner TORX® screws T10-60 and outer TORX® screws E6-16

Set contents	Type	51457	...
35-piece	in sheet steel case		301

51458

TORX® assembly tool set

1/4"

5/16"

3/8"

1/2"

**HAZET**

Type

In SmartCase 185 x 153 x 52 mm. In safety insert system, 2-component soft foam-material inlay.

Quality

Chrome-vanadium steel.

Note:

Torx® selector see cat.-no. 37930.



51458

Set contents

	4	Ring wrenches for outer TORX® screws E6 x 8 / 10 x 12 / 14 x 18 / 20 x 24
	1	Connecting piece 5/16 inch x 3/8 inch
	1	Connecting piece 5/16 inch x 1/2 inch
	1	Connecting piece 1/4 inch x 1/4 inch
1/4"	4	Socket wrench inserts for outer TORX® screws E5 / 6 / 7 / 8
	7	Bits for inner TORX® screws T 10 / 20 / 25 / 27 / 30 (length 26 mm) T 25 (length 65 mm) T 30 with bore (length 26 mm)
5/8"	3	Bits for inner TORX® screws T40 / 45 / 50
3/8"	3	Socket wrench inserts for outer TORX® screws E10 / 12 / 14
1/2"	3	Socket wrench inserts for outer TORX® screws E10 / 12 / 14
	2	Screwdriver inserts for inner TORX® screws T55 / 60

Set contents	Type	51458	...
29-piece	in SmartCase		101



51459

TORX® assembly tool set



Quality
Chrome-vanadium steel.

51459

Type
In SmartCase 355 x 235 x 52 mm. In safety insert system, 2-component soft foam-material inlay.

Note:
Torx® selector see cat.-no. 37930.



Set contents

- 4 Ring wrenches for outer TORX® screws E 6 x 8 / 10 x 12 / 14 x 18 / 20 x 24
- 10 Screwdrivers for inner TORX® screws T 6 / 7 / 8 / 9 / 10 / 15 / 20 / 25 / 27 / 30
- 11 Offset screwdrivers for inner TORX® screws T 6 / 7 / 8 / 9 / 10 / 15 / 20 / 25 / 27 / 30 / 40
- 1/4" 5 Socket wrench inserts for outer TORX® screws E 4 / 5 / 6 / 7 / 8
- 12 Bits ResistTORX® with bore 26 mm (T 6 without bore) T 6 / 7 / 8 / 9 / 10 / 15 / 20 / 25 / 25 (110 mm) / 27 / 30 / 40
- 1 Connecting piece 1/4 inch to 1/4 inch
- 1 Connecting piece 1/4 inch to 3/8 inch
- 1 Bit reversible ratchet 115 mm (20 teeth)
- 3/8" 4 Socket wrench inserts for outer TORX® screws E 10 / 11 / 12 / 14
- 2 Screwdriver inserts for inner TORX® screws T 40 / 45
- 1/2" 4 Socket wrench inserts for outer TORX® screws E 16 / 18 / 20 / 24
- 3 Screwdriver inserts for inner TORX® screws T 50 / 55 / 60

Set contents	Type	51459	...
58-piece	in SmartCase		101

51463

TORX® socket wrench set



Quality
Chrome-vanadium steel.

51463

Type
In SmartCase 355 x 235 x 52 mm. In safety insert system, 2-component soft foam-material inlay.

Note:
TORX® selector see cat.-no. 37930.

Use
For outer TORX® screws.



Set contents

- 3 Inserts 1/4 inch, E 4 / E 5 / E 6
- 3 Inserts 3/8 inch, E 8 / E 10 / E 12
- 3 Inserts 1/2 inch, E 14 / E 18 / E 20

Set contents	Type	51463	...
9-piece	in SmartCase		301

51465 - 51473

TORX® socket wrench inserts



Use
For outer TORX® screws.

51465
ATORN®

51465

51473

Note:
TORX® selector, see cat.-no. 37930.

51473
HAZET
Type
Chrome-plated, polished.
Quality
Chrome-vanadium steel.



Size E	Length mm	ATORN®		HAZET®	
		51465	...	51473	...
10	38.0		101		301
11	38.0		102		302
12	38.0		103		303
14	38.0		104		304
16	38.0		105		305

Size E	Length mm	ATORN®		HAZET®	
		51465	...	51473	...
18	38.0		106		306
20	38.0		107		307
22	38.0		108		308
24	38.0		109		309
24	41.2				308

51476

XZN screwdriver set

1/2"



Type

- Anti-slip, knurled
- In SmartCase
- In safety insert system, 2-component soft foam-material inlay

Use

For Trisquare socket head screws (Allen key XZN).

Quality

CVD-TiN coating for longer tool life.

NEW

51476



Set contents

● 6	Inserts XZN short M 8 / 10 / 12 / 14 / 16 / 18
● 2	Inserts XZN long M 8 / 14
● 2	Inserts XZN extra long M 10 / 12

Set contents

Type

51476

...

10-piece

in SmartCase

101

51480

XZN screwdriver inserts

1/2"



Type

Chrome-plated, blade burnished.

Use

For Trisquare socket head screws (Allen key XZN).

Quality

Chrome-vanadium steel.

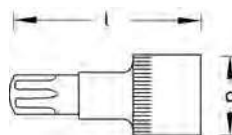

51480



51480 L



Size XZN

l

mm

d

mm

51480

...

5

55

23

301

6

55

23

302

L 6

100

23

303

8

55

23

304

L 8

100

23

305

size XZN

l

mm

d

mm

51480

...

10

55

23

306

L 10

100

23

307

12

55

23

308

L 12

100

23

309

51484

RIBE CV screwdriver inserts

1/2"



Type

Chrome-plated, drop-forged, blade CVD-TiN coated.

Use

For inner spline screws (RIBE CV).

Quality

Chrome-vanadium steel.

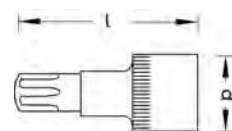

51484



Size RIBE CV

l

mm

d

mm

51484

...

5

63

23

#

101

6

63

23

102

8

63

23

103

10

63

23

104

size RIBE CV

l

mm

d

mm

51484

...

12

63

23

#

105

14

63

24,6

#

106

16

63

24,6

#

107

LARGE SELECTION – SIMPLE SEARCH

Always remember! CATALOGUE VOLUME [1]

The specialist catalogue for machining and clamping technology.

Experience our extensive product range of quality tools from ATORN.

Performance requires quality



Ratchet adapters | Reversible ratchets

51542

Ratchet adapter

1/2"



Type

Very stable design, reversible for right and left-hand rotation.

Use

As ratchet adapter for the drive element cat.-no. 51535-51541, but also as a ratchet for torque wrenches with 1/2 inch connection square.

Quality

Chrome alloy steel, nickel-plated.

51542



Overall length mm	Ø mm	No. of teeth	51542	...
67.5	40	20	#	101

51503

Reversible geared ratchets DIN 3122/ISO 3315

1/2"



Type

Finely toothed and robust thanks to double catch, with square piece.

Quality

31 Cr V3.

51503 102

Square piece

51503 101



	Overall length mm	51503	...
Ratchet	270		101
Square piece	38		102

51503 102



51506 - 51510

Reversible ratchets DIN 3122/ISO 3315

1/2"

Type

Chrome-plated, extremely robust ratchets with turning knob for clockwise and counterclockwise operation and ergonomically-shaped handle made of plastics.

Quality

Chrome-vanadium steel.

51506 101



Finely toothed (72 teeth, ratcheting angle 5°), with ball lock.

Quality

31 Cr V3.

51508 101



Finely toothed (72 teeth, rotational angle 5°), makes working even extremely jammed fittings possible. Large reverse button on the top facilitates switching the direction of the ratchet. Protection against unintended switching due to a deeper lying reverse button. Tempered investment casting cover plate and reverse button for difficult operating conditions. Inductively hardened internal toothing guarantees high duty and long tool life. Robust body with forged, ergonomic handle. Non-slip 2-component handle for optimum handling.



51506



51507



51508

51507



Finely toothed (60 teeth, rotational angle 6°)

Quality

Chrome alloy steel.

51510 101-102



Finely toothed, 72 teeth, rotational angle 5°

The thumb rest enables the user to press onto the ratchet head without activating the reverse switch. Quick reversal thanks to one-hand operation.



51510 101

51510 102

Extra long ratchet 400 mm.



51510 102

		51506	...		51507	...		51508	...		51510	...
Overall length mm												
245								101				
250											101	
265							201					
270			101									
XL 400												102



51508

51512

Reversible ratchet DIN 3122/ISO 3315

1/2"



Type

With reverse lever.

Finely toothed, rotational angle 6°, non-slip

2-component handle with hanging hole.

Ball lock, with quick-release push button.

Quality

Vanadium steel 31CrV3.

51512



Overall length mm	51512	...
270		101

Hand Tools

Type

Chrome-plated, extremely robust ratchets with reversible knob for clockwise and counterclockwise operation and ergonomically-shaped handle made of plastics.

Quality

Chrome-vanadium steel.

51515 201



With reverse lever and quick-release push button. Finely toothed, 72 teeth. Non-slip 2-component handle with hanging hole.

51517 101



With reverse lever, quick-release push button. Centre position arrest and ball lock. 32 teeth, ratcheting angle 11.25°.

51518 101



With reverse lever, 36 teeth.

Quality

Chrome alloy steel.

51518 102



With reverse lever, QuickRelease safety lock and 2-component handle, 60 teeth. Working angle 6° for working hard-to-reach areas.

Quality

Chrome alloy steel.

51519 201



With reverse lever, polished, 32 teeth.

51519 202



With reverse lever, polished, 32 teeth. With safety lock and quick-release push button.

51519 204



With reverse lever, 32 teeth, rotational angle 12°. Shank Ø 15 mm. Low effort expended thanks to long lever. Non-slip 2-component handle.

Use

Particularly suitable for utility vehicles and agricultural machinery as well as industrial facilities.

Quality

Hardened and tempered special steel.

51520 201



With reverse lever, nickel-plated and chrome-plated. Rounded and highly polished surfaces without sharp edges. 80 teeth,

Return angle 4.5°. 2 claws supporting 7 teeth on each in contact with the gear. Exceeds torque requirements as per ISO and ASME. With warm, comfortable 2-component handle, non-slip with extended width.

Quality

Vanadium-extra, precision-forged and heat-resistant.

51513 100



With reverse lever and quick-release push button. Chrome-plated, 36 teeth.

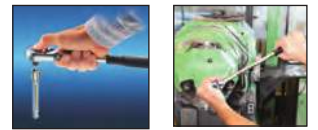

	ATORN	GEDORE	STAHLWILLE	HAZET	BAHCO	SALTUS
Overall length mm	51515	...	51517	...	51519	...
250						100
255		201				
265.5					101	
265.5					102	
270			101			201
275						201
275						202
389						204

51522

One-Hand reversible ratchets DIN 3120/ISO 1174



Type

Nickel-plated and chrome-plated, highly polished. Smooth running one-hand reverse ring on the handle for reversal of operation by a simple, short turn. Integrated quick-turning disc on the square section for easier tightening and loosening of screw

connections. Unlocking device of ball catch for effortless and quick push-button exchange of socket wrench bits. **Fine-pitched teeth (60 teeth)**, return angle 6°. Plastic handle with hanging hole.

Quality

Vanadium-extra.



Overall length mm	51522	...
260		301



51523

Extendible reversible ratchet

Type

- 5 adjustable and lockable positions from 305 to 445 mm
- Finely toothed, (72 teeth).

- Insert quick release

Quality

Chrome-vanadium steel, matt chrome-plated.

Adjusting range mm	51523	...
305 - 445		201



51524

Extendible reversible ratchet

1/2"



- Type**
- Infinitely extendible from 410 to 590 mm
 - Low effort expended thanks to long lever
 - Max. torque 600 Nm
 - Fixing is made easy thanks to anti-slip lock ring
 - Ratchet wheel 32 teeth
 - Surface chrome-plated, polished head.

Use
Particularly suitable for utility vehicles and agricultural machinery as well as industrial facilities.

Quality
Chrome-vanadium.



51524

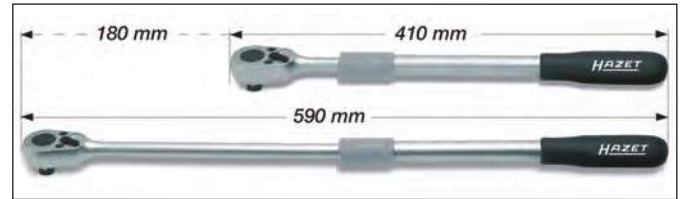

Adjusting range mm	51524	...
410 - 590		101

51527

Joint reversible ratchet

1/2"



- Type**
With reverse lever.
Chrome finish and polished.

Extremely robust ratchet with clockwise and counter-clockwise operation, swivelling ratchet head and ergonomic plastic handle.

Quality
Chrome-vanadium steel.



51527

Overall length mm	51527	...
270		201

51530 - 51532

Readyflex® Freiraumknarre®

1/2"



- Use**
This ratchet combines all the advantages of a ratchet with a flexible lever arm with those of a ratchet with a rigid lever arm. It guarantees full leverage, especially in angled positions. It is therefore suitable for application in hard-to-reach areas.
- Quality**
Chrome-vanadium steel.

51530
Type
Reverse function ring, 7 steps, lockable by means of yellow Flex button, finely toothed (72 teeth), chrome-plated. **With moveable lever arm.** The sliding guide in **inner ring (1)** enables the user to press onto the ratchet head without activating the reverse switch. Reverse function by means of one-hand operation on **outer ring (2)**.

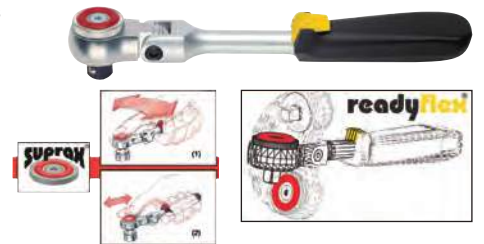

51530

51532
Type
Reverse lever, 7 switch steps, joint lockable by means of yellow Flex button. Locking mechanism for tools by means of red button in ratchet head.



51532

Overall length mm	51530	...	51532	...
260	#	201		
270				101

51534

Zyklop ratchet



1/2"



- Type**
- Flywheel mass design and anti-slip freewheel sleeve for a high working speed
 - Freely swivelling ratchet head
 - Defined position at 0°, 90° to the left and right as well as 15° from 90° towards the inside
 - Used like a conventional screwdriver when in the 0° position
 - Push-button release
 - Left/right switching
 - Finely toothed
 - Small return angle of 5°
 - Multi-component Kraftform handle for fatigue-free working



The ratchet head swivels freely and can be unlocked in any position by sliding the switch which is located on both sides.



The socket lock accelerates the fitting and removal of inserts and extensions. The ball lock provides a secure fit for sockets and accessories and provides reliable safety while tightening. Simply press the release button and tool exchange is possible in any defined position.



The flywheel design accelerates the screwing process.



The Zyklop ratchet is quickly and easily reversible in any position by means of the knurl.



51534

Overall length mm	51534	...
277		101

51535 - 51541

Drive elements

1/2"

Type
Chrome-plated, drop-forged.
Quality
Chrome-vanadium steel.

51535
ATORN®

51537
DBGM
GEDORE

Type
Ground. Easy locking and unlocking by turning the handle.
Use
Lock against unintended unlocking.

51538
GEDORE

51538 202
GEDORE
Crank

Type
With rotating ergonomically-shaped handle.

51539
STAHLWILLE
Quality
Chrome alloy steel.

51540
STAHLWILLE
Type
With QuickRelease safety lock.
Quality
Chrome alloy steel.

51541
HAZET

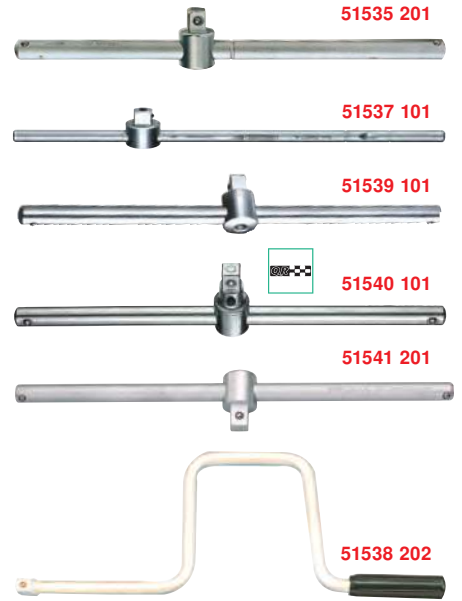

	51535	...	51537	...	51538	...	51539	...	51540	...	51541	...
Handle with sliding piece	201		101		201		101		101		201	
Crank					202							
Universal joint	203				203		103		103		203	
Adapter 1/2 inch □ x 3/8 inch ■	204				204		104				204	
Adapter 1/2 inch □ x 3/4 inch ■	205				205		105				205	
FixGRIP-Adapter 1/2 inch □ x 3/4 inch ■							106					

51550 - 51560

Extensions

1/2"

Type
Chrome-plated, drop-forged.
Quality
Chrome-vanadium steel.

51550
ATORN®

51551
GEDORE

With release. Safety ring to prevent unintentional release of the socket wrench bit.

51552
GEDORE

51553
STAHLWILLE
Quality
Chrome alloy steel.

51554
HAZET
51556
FACOM
51560
STAHLWILLE
With QuickRelease safety lock.
Quality
Chrome alloy steel.



	51550	...	51551	...	51552	...	51553	...	51554	...	51556	...	51560	...
Length approx. mm														
52								300						101
75	101					201		301		201				
125	102		101			202		302		202	#	202		
130														102
250	103		102			203		303		203		203		
255														103
500												204		

51562

Swivelling extensions

1/2"



Quality
Chrome-vanadium steel.



Type
Chrome-plated, polished.
Use
With ball-type, conical outer square. Allows a flex angle to any direction of 12.5°.

51562 201



51562 202



51562 203



Length mm	51562	...
46		201
123		202
248		203

51565

Adapter set

1/4" 3/8" 1/2" 3/4"



NEW

Set contents

1/4 inch	<input type="checkbox"/>	x	3/8 inch	<input checked="" type="checkbox"/>
3/8 inch	<input type="checkbox"/>	x	1/4 inch	<input checked="" type="checkbox"/>
3/8 inch	<input type="checkbox"/>	x	1/2 inch	<input checked="" type="checkbox"/>
1/2 inch	<input type="checkbox"/>	x	3/8 inch	<input checked="" type="checkbox"/>
1/2 inch	<input type="checkbox"/>	x	3/4 inch	<input checked="" type="checkbox"/>
3/4 inch	<input type="checkbox"/>	x	1/2 inch	<input checked="" type="checkbox"/>

Type
In SmartCase 185 x 153 x 52 mm.
In safety insert system,
2-component soft foam-material inlay.
Quality
Chrome-vanadium steel.



51565

Set contents	Type	51565	...
6-piece	in SmartCase		201

51568

Open-end double hexagon ring wrench (crowfoot wrenches)

1/2"



Quality
Chrome-vanadium steel.

Type
Chrome-plated, with inside square drive.
Use
Especially for working in hard-to-reach places.



51568

AF mm	51568	...	AF mm	51568	...
30		101	41	#	104
32		102	46	#	105
36		#	103		



When your voice counts ...

... your suggestions are heard.

www.atorn.de

ATORN[®]
Performance requires quality

51569

Hexagonal socket wrench set

3/4"

ATORN®

Type

Inserts with energy profile, bore and knurl.

Quality

Chrome-vanadium steel.

51569



Set contents

- 12 Hexagonal inserts with energy profile AF 22 / 24 / 27 / 30 / 32 / 36 / 38 / 41 / 46 / 50 / 55 / 60 mm
- 1 Reversible ratchet 2.000 Nm torque
- 1 Handle with sliding piece 500 mm
- 2 Extensions 200 / 400 mm

Set contents	Type	51569	...
16-piece	in sheet steel case		101

51570

Hexagonal socket wrench set

3/4"

GEDORE

Type

Chrome-plated, warm forged, with locking pin.

Quality

Vanadium 31CrV3.

51570



Set contents

- 10 Hexagonal inserts with UD profile AF 22 / 24 / 27 / 30 / 32 / 36 / 38 / 41 / 46 / 50 mm
- 1 Reversible ratchet
- 1 Handle with sliding piece
- 2 Extensions 200 / 400 mm

Set contents	Type	51570	...
14-piece	in sheet steel case		201

51571

Hexagonal socket wrench sets

3/4"

STAHLWILLE

Type

Chrome-plated.

With AS-drive profile and Quick-Release system (one-hand safety lock).

Quality

HPQ heavy-duty steel.

Set contents 51571 201

- 10 Hexagonal inserts with AS-drive profile AF 22 / 24 / 27 / 30 / 32 / 34 / 36 / 41 / 46 / 50 mm
- 1 Reversible ratchet
- 1 Handle
- 1 Sliding piece
- 1 Angle joint
- 2 Extensions 200 / 400 mm

51571 201



Set contents 51571 202

- 9 Hexagonal inserts with AS-drive profile AF 32 / 34 / 36 / 38 / 41 / 46 / 50 / 55 / 60 mm
- 1 Reversible ratchet
- 1 Handle
- 1 Sliding piece
- 1 Angle joint
- 2 Extensions 200 / 400 mm

51571 202



Set contents	Type	51571	...
16-piece	in sheet steel case		201
15-piece	in sheet steel case		202

51572

Double hexagonal socket wrench set

3/4"

HAZET

Set contents

- 10 Double hexagonal inserts AF 22 / 24 / 27 / 30 / 32 / 36 / 38 / 41 / 46 / 50 mm
- 1 Reversible ratchet head
- 1 Bar with ball and locking pin
- 1 Spline end with ball lock
- 2 Extensions 200 / 400 mm

51572



Set contents	Type	51572	...
15-piece	In metal box	#	101



51573 - 51575 Hexagonal socket wrench inserts DIN 3124/ISO 2725



Type
Chrome-plated, drop-forged.



51573
With UD profile, non-slip knurling and locking pin.
Quality
31 Cr V3.

51575
 With AS-drive profile.
Quality
HPQ heavy-duty steel.

51574
 Quality
Chrome-vanadium steel.



AF	l	approx. d	approx. mm	51573	...	51575	...	51574	...
19	50	28.0						302	
21	51	28.0				#		303	#
22	51	33.0	#	304		#		304	304
24	51	35.0		305				305	305
27	55	39.0		306		#		306	306
30	59	42.5		308				308	308
32	59	45.0		309				309	309
34	59	48.0	#	311		#		311	#

AF	l	approx. d	approx. mm	51573	...	51575	...	51574	...
36	62	50.0				313		313	313
38	62	52.5				314		#	314
41	68	56.5				315		315	315
46	73	63.0				317		317	317
50	75	68.0				318	#	318	#
55	82	74.0				319	#	319	319
60	88	80.5				320		#	320

51577 Double hexagonal socket wrench inserts DIN 3124/ISO 2725



Type
With UD profile. Chrome-plated, drop-forged.
Quality
Chrome-vanadium steel.

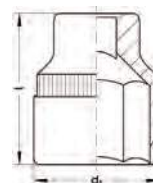

AF	l	d ₁	51577	...
21	51.5	32.0	#	203
22	51.5	33.3	#	204
24	51.5	35.8		206
27	54.5	39.6	#	209
30	57.5	43.3		212

AF	l	d ₁	51577	...
32	57.5	45.8		213
36	59.5	50.8		217
41	62.5	57.1		219
46	65.5	63.3		221
50	68.5	68.3	#	222

51581 - 51582 Hexagonal screwdriver inserts



Use
For Allen screws, for high loads, narrow tolerances.



51581
Type
Chrome-plated, centres burnished, with non-slip knurling.
Quality
Vanadium special steel.

51582
 Type
Chrome-plated.
Quality
Chrome alloy steel.

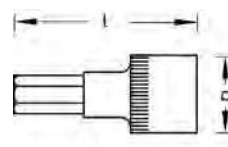

AF	l	d	51581	...	51582	...
14	80	36			201	101
17	80	36			202	102

AF	l	d	51581	...	51582	...
19	80	36			203	103
22	80	39			204	104

51583 TORX® screwdriver inserts



Use
For inner TORX® screws.

Quality
Chrome-vanadium steel.

Note:
Torx® selector see cat.-no. 37930.



Size T	Length mm	51583	...
60	80	#	101
70	80		102
80	80		103

Size T	Length mm	51583	...
90	80	#	104
100	80	#	105

51584

Reversible geared ratchets DIN 3122/ISO 3315

3/4"

GEDORE 

Type

Chrome-plated, with locking pin and internal
toothing (ratcheting angle 10°). **With square piece.**

Quality

Vanadium 31CrV3.

51584 201



	Overall length mm	51584	...
Ratchet	510.0	201	
Square piece	51.5	202	

51584 202
Square piece

51584 202



51586

Reversible ratchet DIN 3122/ISO 3315

3/4"

GEDORE 

Type

Chrome-plated, extremely robust ratchet **with
switch knob for clockwise and counterclockwise
operation**, locking pin and internal toothing (rotational
angle 7.2°).

Quality

Vanadium 31CrV3.

51586

	Overall length mm	51586	...
	510	201	



51588 - 51591

Reversible ratchets DIN 3122/ISO 3315

3/4"

Type

Chrome-plated, extremely robust ratchets with
reversible knob for clockwise and counterclockwise
operation and locking pin.

Quality

Chrome-vanadium steel.

51590 101



Ratchet head

Type

With reverse lever. 36 teeth.

Without handle (cat.-no. 51590 102).

With **Quick-Release system** (one-hand safety lock).

Quality

Chrome alloy steel.

51588



51588

GEDORE 

Type

With **switch knob**. Finely toothed
(rotational angle 5°).

51589



Type

With **reverse lever**. Ratchet (32 teeth) with ball lock.
Shank with ejector bolt for locking pin.

51590 102



Handle

Use

For ratchet head
cat.-no. 51590 101.

Quality

Chrome alloy steel.

51589



51590 101

51590 102



Type	Overall length mm	51588	...	51589	...	51590	...
Ratchet assembly	620	201		101			
Ratchet head	165					101	
Handle	510					102	

51587

Extendible reversible ratchet

3/4"

Type

- **With reverse lever**
- Extra wide knurled handle
- Length can be adjusted in 6 steps
(610 / 690 / 770 / 850 / 930 / 1010 mm)

NEW

51587

Adjusting range mm	Max. load capacity Nm	51587	...
615 - 1015	1800	101	

51592 - 51595

Drive elements

3/4"

Type

Chrome-plated, drop-forged.

Quality

Chrome-vanadium steel.

51592

GEDORE 

51595



Quality

Chrome alloy steel.

51592 102



51593



51593 101

	51592	...	51593	...	51595	...
Handle with sliding piece				101		
Universal joint		102				
Adapter 3/4 inch <input type="checkbox"/> x 1/2 inch <input checked="" type="checkbox"/>		103		103		203
Adapter 3/4 inch <input type="checkbox"/> x 1 inch <input checked="" type="checkbox"/>		104				204



51595 203



51596 - 51598

Extensions

3/4"

Type
Chrome-plated, drop-forged.
Quality
Chrome-vanadium steel.

51596
GEDORE

51598
STAHLWILLE
Qualität
Chrome-Alloy-Steel.

51597
HAZET



Overall length mm	51596	...	51597	...	51598	...
200			101		101	102
400			102		102	103

51600

Double hexagonal socket wrench set

1"

GEDORE

Quality
Vanadium 31CrV3.

Set contents	Type	51600	...
15-piece in sheet steel case			101



Set contents	
10	Double hexagonal inserts with UD profile AF 36 / 41 / 46 / 50 / 55 / 60 / 65 / 70 / 75 / 80 mm
1	Reversible ratchet
1	Sliding T-bar
1	Sliding piece
2	Extensions 200 / 400 mm

51603

Double hexagonal socket wrench inserts DIN 3124/ISO 2725

1"

GEDORE

Type
With UD profile. Chrome-plated, drop-forged,
with locking pin.

Quality
Vanadium 31CrV3.

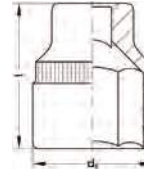

AF mm	l mm	d ₁ mm	51603	...
36	70	53.9		203
41	70	60.1	#	204
46	75	66.4		205
50	75	71.4	#	206
55	78	77.6		207

AF mm	l mm	d ₁ mm	51603	...
60	83	83.9	#	208
65	86	90.1		209
70	90	96.4		210
75	93	102.6	#	211
80	95	108.9	#	212

51606

Reversible ratchet with sliding T-bar DIN 3124/ISO 2725

1"

GEDORE

Type
Chrome-plated, head finely ground. Extremely
robust ratchet with reverse lever for clockwise and

counter-clockwise operation, locking pin and centre
position arrest. Turning angle 11.25°.
Quality
Vanadium 31CrV3.



Overall length mm	51606	...
810		201

51609

Drive elements

1"

GEDORE

Type
Chrome-plated, drop-forged.
Quality
Vanadium 31CrV3.

51609 101
Sliding T-bar
Sliding piece with ball lock.



	Length mm	51609	...
Sliding T-bar	700		101
Adapter 1 inch <input type="checkbox"/> x 3/4 inch <input checked="" type="checkbox"/>	75		102

51612

Extensions

1"

GEDORE

Type
Chrome-plated, drop-forged.

Quality
Vanadium 31CrV3.



Overall length mm	51612	...
200		101
400		102

51614

Hexagon servo screwdriver bits



Type

Drive: 1/4 inch square end DIN 3121 shape G 6.3,
Output: Inner hexagon DIN 475/2.

Quality

Chrome-vanadium special steel.

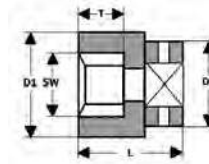

51614



AF mm	L mm	D ₁ mm	D ₂ mm	T mm	51614	...
6	23	10.0	13	6.0		106
7	23	11.3	13	6.0		107
8	23	12.5	13	6.0		108
10	23	15.0	13	7.0		110

AF mm	L mm	D ₁ mm	D ₂ mm	T mm	51614	...
11	23	16.3	13	8.0	#	111
12	23	17.0	13	8.0	#	112
13	23	18.8	13	8.0		113

51616

Hexagon servo screwdriver bits, with magnet



Type

With strong permanent magnet.

Drive: 1/4 inch square end DIN 3121 shape G 6.3,
Output: Allen DIN 475/2.

Quality

Chrome-vanadium special steel.

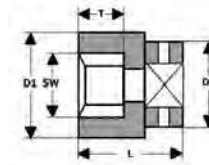

51616



AF mm	L mm	D ₁ mm	D ₂ mm	T mm	51616	...
5	23	8.8	13	3.0	#	101
5.5	23	9.5	13	3.0	#	102
6	23	10.0	13	3.0		103
7	23	11.3	13	3.0		104
8	23	12.5	13	3.0		105

AF mm	L mm	D ₁ mm	D ₂ mm	T mm	51616	...
9	23	13.8	13	4.0	#	106
10	23	15.0	13	4.0		107
11	23	16.3	13	5.0	#	108
13	23	18.8	13	5.0		109

51617

Hexagon servo screwdriver bits, long with magnet



Type

Long type, with spring-loaded magnet.

Drive: 1/4 inch square end DIN 3121 shape G 6.3,
Output: Allen DIN 475/2.

Quality

Chrome-vanadium special steel.

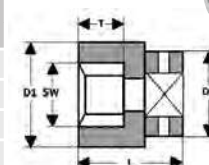

51617



AF mm	L mm	D ₁ mm	D ₂ mm	T mm	51617	...
7	50	11.3	13	4.0	#	101
8	50	12.5	13	4.0		102
10	50	15.0	13	4.0		103
13	50	18.8	13	6.0	#	104

51613

Servo screwdriver bit accessories



Quality

Chrome-vanadium special steel.

51613 401

Type

With strong permanent magnet.

Drive: 1/4 inch square end DIN 3121 shape G,
Output: 1/4 inch inner hexagon DIN 3126 shape D 6.3.

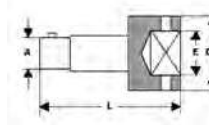

51613 301-302



51613 301-302

Type

Drive: 1/4 inch square end DIN 3121 shape G 6.3,
Output: 1/4 inch outer square DIN 3121 shape E -
with spring-loaded pin.

	E Inch	A Inch	D ₂ mm	L mm	51613	...
Extension	1/4	1/4	13	50		301
Extension	1/4	1/4	13	150		302
Bit holder	1/4	D 6.3	13	62		401

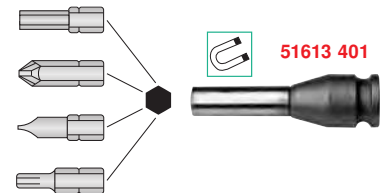

51613 401

51627

Servo screwdriver connecting piece



Type

With quick-change toolholder.

Drive: 1/4 inch square end DIN 3121 shape G 6.3,
Output: Outer square DIN 3121 - with ball lock.

Quality

Chrome-vanadium special steel.

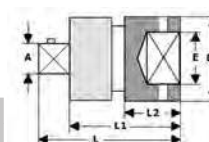

51627



E Inch	A Inch	D ₂ mm	L mm	L ₁ mm	L ₂ mm	51627	...
1/4	1/4	13	35	28	10	#	101

Impact tools

51615

Hexagon servo screwdriver bits

3/8"



Type

Drive: 3/8 inch square end DIN 3121 shape G 10,
Output: Inner hexagon DIN 475/2.

Quality

Chrome-vanadium special steel.

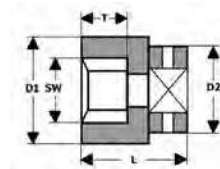

51615

AF mm	L mm	D ₁ mm	D ₂ mm	T mm	51615	...
8	30	14.0	19	6.0		203
10	30	16.0	19	7.0		205
11	30	17.5	19	8.0		206
12	30	19.0	19	9.0		207
13	30	20.0	22	9.0		208

AF mm	L mm	D ₁ mm	D ₂ mm	T mm	51615	...
14	30	21.0	22	9.0		209
15	30	22.0	22	11.0		210
16	30	24.0	22	11.0		211
17	30	25.0	22	11.0		212

51619

Hexagon servo screwdriver bits, with magnet

3/8"



Type

With strong permanent magnet.

Drive: 3/8 inch square end DIN 3121 shape G 10,
Output: Inner hexagon DIN 475/2.

Quality

Chrome-vanadium special steel.

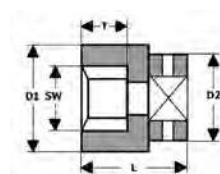

51619

AF mm	L mm	D ₁ mm	D ₂ mm	T mm	51619	...
8	30	14.0	19	3.0	#	101
9	30	15.0	19	4.0	#	102
10	30	16.0	19	4.0		103
11	30	17.5	19	5.0	#	104
13	30	20.2	22	5.0		106

AF mm	L mm	D ₁ mm	D ₂ mm	T mm	51619	...
14	30	21.0	22	6.0	#	107
15	30	22.0	22	6.0	#	108
16	30	24.0	22	6.0	#	109
17	30	25.0	22	6.0		110

51620

Inner hexagon servo screwdriver bits

3/8"



Type

Drive: 3/8 inch square end DIN 3121 shape G 10,
Output: Outer hexagon DIN/ISO 2963.

Quality

Chrome-vanadium special steel.

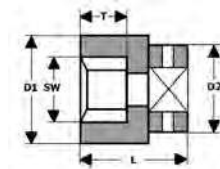

51620

AF mm	L mm	D ₂ mm	51620	...
5	50	19		101
6	50	19		102
8	50	19		103

AF mm	L mm	D ₂ mm	51620	...
10	50	19		104
12	50	19	#	105
14	50	19	#	106

51628

Inner TORX® servo screwdriver bits

3/8"



Type

Drive: 3/8 inch square end DIN 3121 shape G 10,
Output: TX for inner-TORX® screws.

Quality

Chrome-vanadium special steel.

Note:

Torx® selector see cat.-no. 37930.

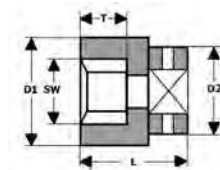

51628

Size T	L mm	D ₂ mm	51628	...
20	50	19	#	101
25	50	19		102
27	50	19	#	103

Size T	L mm	D ₂ mm	51628	...
30	50	19		104
40	50	19		105

51618

Outer Torx® servo screwdriver bits

3/8"



Type

Drive: 3/8 inch square end DIN 3121 shape G 10,
Output: E profile for all outer TORX® screws.

Quality

Chrome-vanadium special steel.

Note:

Torx® selector see cat.-no. 37930.

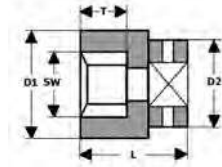

51618

Size	L	D ₁	D ₂	T	51618	...
E	mm	mm	mm	mm	#	
5	32	9.0	19	4.0	#	201
6	32	10.2	19	4.0	#	202
7	32	10.2	19	5.0	#	203
8	32	10.5	19	5.0		204

size	L	D ₁	D ₂	T	51618	...
E	mm	mm	mm	mm		
10	32	12.5	19	6.0		205
12	32	14.9	19	8.0		206
14	32	17.2	19	9.0		207

51621

Servo screwdriver bit accessories

3/8"

Quality

Chrome-vanadium special steel.

51621 101-302

Type

Drive: 3/8 inch square end DIN 3121 shape G 10,
Output: Outer square, DIN 3121 shape E - with
spring-loaded pin.

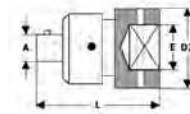

51621 101



51621 303

Type

Drive: 3/8 inch square end DIN 3121 shape G 10,
Output: 5/16 inch inner hexagon DIN 3126 shape
D 8.

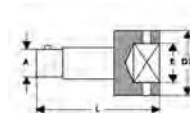

51621 201-203



51621 304

Type

Drive: 3/8 inch square end DIN 3121 shape G 10,
Output: 1/4 inch inner hexagon DIN 3126 shape
D 6.3.

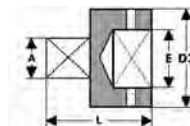

51621 301-302

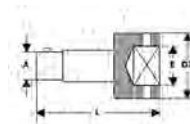

51621 303

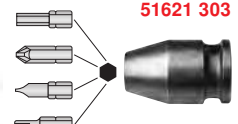

	E	A	D ₂	L		51621	...
	Inch	Inch	mm	mm			
Ball joint	3/8	3/8	22	60	-		101
Extension	3/8	3/8	19	75	-		201
Extension	3/8	3/8	19	150	-		202
Extension	3/8	3/8	22	300	-		203
Adapter	3/8	1/4	19	32	-		301
Adapter	3/8	1/2	22	36	-		302
Bit holder	3/8	D 8	19	38	-		303
Bit holder with quick-change chuck	3/8	1/4	19	45	-		304
Rubber ring	-	-	19	-	10 pcs.		401
Rubber ring	-	-	22	-	10 pcs.		402
Safety pin	-	-	19	-	10 pcs.		501
Safety pin	-	-	22	-	10 pcs.		502

51621 304



51621 401-402



51621 501-502



51622

Servo screwdriver connecting piece

3/8"

Type

With quick-change toolholder.

Drive: 3/8 inch square end DIN 3121 shape G 10,
output: Outer square, DIN 3121 - with ball lock.

Quality

Chrome-vanadium special steel.

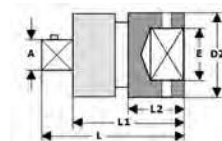

51622

E	A	D ₂	L	L ₁	L ₂	51622	...
Inch	Inch	mm	mm	mm	mm		
3/8	3/8	20	46	35	17		101

Impact tools

51623

Hexagon servo screwdriver bits, plastic-covered

1/2"



Type

Plastic-coated in order to prevent damage to aluminium wheels.
Plastic sheath can be taken off if necessary (low distance between wheel nut and wheel rim bore).
Different colours for different sizes.

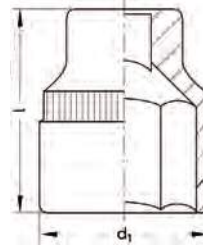

51623 101

Set contents	AF mm	Type	51623	...
3-piece	17 / 19 / 21	in plastic box		101

Size mm	d ₁ mm	l mm	Torque max. Nm	Colour	51623	...
17	27	85	450	blue		201
19	29	85	550	yellow		202
21	31	85	550	red		203

51623 201



51623 202



51623 203



51624 - 51626

Hexagon server screwdriver bits

1/2"



Type

Drive: 1/2 inch square end DIN 3121 shape G 12.5,
Output: Inner hexagon DIN 475/2.

Quality

Chrome-vanadium special steel.

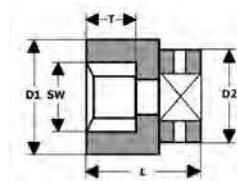

51624



51626

AF mm	L mm	D ₁ mm	D ₂ mm	T mm	short	
					51624	...
10	38	17.0	25	8.0		203
11	38	18.5	25	9.0		204
12	38	19.5	25	9.0		205
13	38	21.0	25	10.0		206
14	38	22.0	25	10.0		207
15	38	23.5	30	10.0		208
16	38	25.03	30	11.0		209
17	38	26.0	30	12.0		210
18	38	27.0	30	13.0		212
19	38	28.0	30	13.0		213
21	38	31.0	30	13.0		216
22	38	32.5	30	13.0		217
24	45	35.0	30	14.0		219
27	50	39.0	30	16.0		220

AF mm	L mm	D ₁ mm	D ₂ mm	T mm	long	
					51626	...
10	78	17.5	25	12.0		103
13	78	21.0	25	12.0		106
14	78	22.5	25	12.0		107
15	78	23.5	30	12.0		108
16	78	25.0	30	12.0		109
17	78	26.0	30	13.0		110
18	78	27.5	30	13.0		112
19	78	28.7	30	13.0		113
22	78	32.0	30	13.0		117
21	78	30.0	30	13.0		116
24	78	35.0	30	20.0		119
27	78	38.5	30	24.0		120

51629

Inner hexagon servo screwdriver bits

1/2"



Type

Drive: 1/2 inch square end DIN 3121 shape G 12.5,
Output: Outer hexagon DIN/ISO 2963.

Quality

Chrome-vanadium special steel.

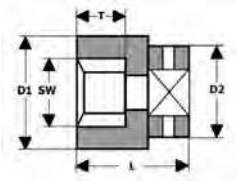

51629

AF mm	L mm	D ₂ mm	51629	...
5	55	25		101
6	55	25		102
8	55	25		103
10	55	25		104

AF mm	L mm	D ₂ mm	51629	...
12	55	25		105
14	55	25		106
17	55	25		107

51632

Inner TORX® servo screwdriver bits



Type

Drive: 1/2 inch square end DIN 3121 shape G 12.5,
Output: TX for inner-TORX® screws.

Quality

Chrome-vanadium special steel.

Note:

Torx® selector see cat.-no. 37930.

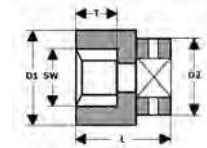

51632

Size	L	D ₂	51632	...
T	mm	mm		
30	55	25		201
40	55	25		202
50	55	25		203

Size	L	D ₂	51632	...
T	mm	mm		
55	55	25		204
60	55	25	#	205

51635

Outer Torx® servo screwdriver bits



Type

Drive: 1/2 inch square end DIN 3121 shape G 12.5,
Output: E profile for outer TORX® screws.

Quality

Chrome-vanadium special steel.

Note:

Torx® selector see cat.-no. 37930.

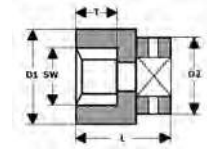

51635

Size	L	D ₁	D ₂	T	51635	...
E	mm	mm	mm	mm		
10	38	15.0	25	7.0		101
12	38	16.0	25	8.0		102
14	38	18.5	25	9.0		103
16	38	20.0	25	10.0		104

Size	L	D ₁	D ₂	T	51635	...
E	mm	mm	mm	mm		
18	38	22.0	25	11.0		105
20	38	25.0	30	12.0		106
24	38	28.5	30	14.0		107

51638

Servo screwdriver bit accessories



Quality

Chrome-vanadium special steel.

51638 201-304

Type

Drive: 1/2 inch square end DIN 3121 shape G 12.5,
Output: Outer square, DIN 3121 shape E - with
spring-loaded pin.

51638 401

Type

Drive: 1/2 inch square end DIN 3121 shape G 10,
Output: 1/4 inch inner hexagon DIN 3126 shape
D 6.3.

51638 402

Type

Drive: 1/2 inch square end DIN 3121 shape G 10,
Output: 5/16 inch inner hexagon DIN 3126 shape
D 8.

51638 403

Type

Drive: 1/2 inch square end DIN 3121 shape G 12.5,
Output: Outer square, DIN 3121 shape E - with
spring-loaded pin.

51638 404

Type

Drive: 1/2 inch square end DIN 3121 shape G 12.5,
Drive: Outer square, DIN 3121 shape F - with
throughhole for pin.

	E	A	D ₂	L	51638	...
	Inch	Inch	mm	mm		
Ball joint	1/2	1/2	30	74		201
Extension	1/2	1/2	25	75		301
Extension	1/2	1/2	25	125		302
Extension	1/2	1/2	25	250		304
Bit holder	1/2	D 6.3	25	38		401
Bit holder	1/2	D 8	25	35		402
Adapter	1/2	3/8	25	38		403
Adapter	1/2	3/4	30	48		404
Rubber ring	-	-	25	-	10 pcs.	501
Rubber ring	-	-	30	-	10 pcs.	502
Safety pin	-	-	25	-	10 pcs.	601
Safety pin	-	-	30	-	10 pcs.	602

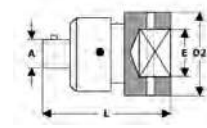

51638 201

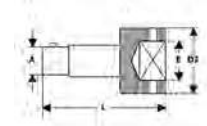

51638 301-304

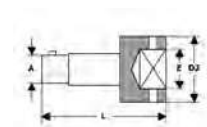

51638 401-402

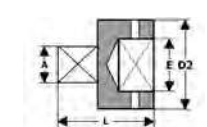
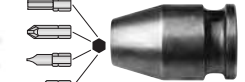

51638 403



51638 501-502



51638 601-602



51639

Servo screwdriver connecting piece



Type

With quick-change toolholder,

Drive: 1/2 inch square end DIN 3121 shape G 12.5,
Output: Outer square, DIN 3121 - with ball lock.

Quality

Chrome-vanadium special steel.

E	A	D ₂	L	L ₁	L ₂	51639	...
Inch	Inch	mm	mm	mm	mm		
1/2	1/2	25	60	44	24		101

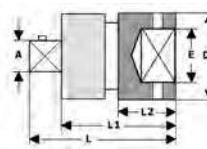

51639



Impact tools

51641 - 51643

Hexagon servo screwdriver bits



Type

Drive: 3/4 inch square end DIN 3121 shape H 20,
Output: Inner hexagon DIN 475/2.

Quality

Chrome-vanadium special steel.

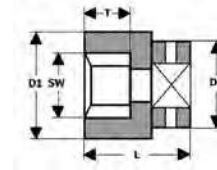

51641



51643



AF mm	L mm	D ₁ mm	D ₂ mm	T mm	short	
					51641	...
17	50	31.0	44	12		202
18	50	32.0	44	12	#	203
19	50	33.0	44	14		204
22	50	37.0	44	16		207
24	50	39.0	44	16		209
27	54	43.0	44	16		212
30	54	47.0	44	23		215
32	56	49.0	44	23		216
33	56	51.0	44	23	#	217
34	56	52.0	44	23		218
36	56	54.0	44	23		220
38	58	57.0	44	24		221
41	58	60.0	44	24		223
46	63	67.0	44	27		224

AF mm	L mm	D ₁ mm	D ₂ mm	T mm	long	
					51643	...
17	95	31	44	20		102
18	95	32	44	20	#	103
19	95	33	44	23		104
22	95	37	44	23		107
24	95	39	44	51		109
27	95	43	44	62		112
30	95	47	44	62		115
32	95	49	44	62		116
33	95	51	44	62	#	117
34	95	52	44	62	#	118
36	95	54	44	62		120

51644

Inner hexagon servo screwdriver bits



Type

Drive: 3/4 inch square end DIN 3121 shape H 20,
Output: Outer hexagon DIN/ISO 2963.

Quality

Chrome-vanadium special steel.

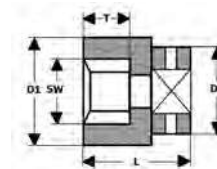

51644



AF mm	L mm	D ₂ mm	51644	...
14	62	44		101
17	62	44		102
19	62	44		103

AF mm	L mm	D ₂ mm	51644	...
22	62	44		104
24	62	44		105
27	62	44		106

51646

Servo screwdriver bits accessories



Type

Drive: 3/4 inch square end DIN 3121 shape H 20,
Output: Outer square, DIN 3121 shape F - with
throughhole for pin.

Quality

Chrome-vanadium special steel.

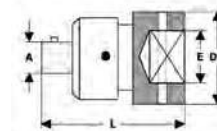

51646 201

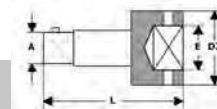

51646 301-303

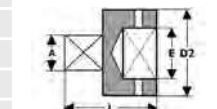

51646 401-403



51646 501

51646 601



	E Inch	A Inch	D ₂ mm	L mm		51646	...
Ball joint	3/4	3/4	44	90	-		201
Extension	3/4	3/4	44	175	-		301
Extension	3/4	3/4	44	250	-		302
Extension	3/4	3/4	44	330	-		303
Adapter	3/4	1/2	44	57	-		401
Adapter	3/4	1	44	63	-		403
Rubber ring	-	-	44	-	10 pcs.		501
Safety pin	-	-	44	-	10 pcs.		601

51647

Servo screwdriver connecting piece



Type

With quick-change toolholder.

Drive: 3/4 inch square end DIN 3121 shape H 20,
output: Outer square DIN 3121 - with ball lock.

Quality

Chrome-vanadium special steel.

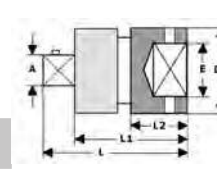

51647



E Inch	A Inch	D ₂ mm	L mm	L ₁ mm	L ₂ mm	51647	...
3/4	3/4	44	78	55	29	#	101

51649 - 51651

Hexagon servo screwdriver bits

1"



Type

Drive: 1 inch square end DIN 3121 shape H 25,
Output: Inner hexagon DIN 475/2.

Quality

Chrome-vanadium special steel.

AF mm	L mm	D ₁ mm	D ₂ mm	T mm	short	
					51649	...
22	58	40	54	17		103
24	58	42	54	17		105
27	58	46	54	17		106
30	60	50	54	21		109
32	60	52	54	21		110
33	60	53	54	21	#	111
34	62	55	54	21	#	112
36	65	56	54	30		113
38	65	59	54	30	#	114
41	67	63	54	31		116
46	74	69.5	54	36		118
50	80	74	54	42		119
55	84	81	54	44		120
60	87	87	54	44		121
65	90	93	54	46		122
70	96	100	54	51		123
75	98	104	86	52		124
80	100	109	86	52	#	125

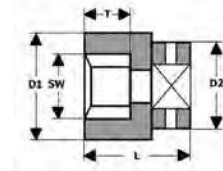

51649



51651



long

AF mm	L mm	D ₁ mm	D ₂ mm	T mm	long	
					51651	...
22	100	40	54	21	#	103
24	100	42	54	21	#	105
27	100	46	54	23		106
30	100	50	54	50		109
32	100	52	54	50		110
33	100	53	54	50	#	111
34	100	55	54	50	#	112
36	100	57	54	64		113
38	100	59.5	54	64	#	114
41	100	64	54	64		116
46	100	69.5	54	62		118

51652

Servo screwdriver bits accessories

1"

Type

Drive: 1 inch square end DIN 3121 shape H 25,
Output: Outer square, DIN 3121 shape F - with
throughhole for pin.

Quality

Chrome-vanadium special steel.

	E Inch	A Inch	D ₂ mm	L mm		51652	...
Ball joint	1	1	54	110	-		101
Extension	1	1	54	175	-		201
Extension	1	1	54	250	-		202
Extension	1	1	54	330	-	#	203
Adapter	1	3/4	54	75	-		301
Rubber ring	-	-	54	-	10 pcs.		401
Safety pin	-	-	54	-	10 pcs.		501

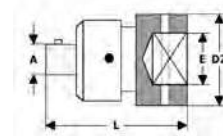

51652 101

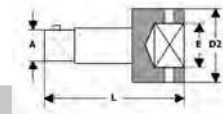

51652 201-203

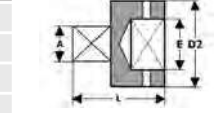

51652 301



51652 401



51652 501



51653

Servo screwdriver connecting piece

1"

Type

With quick-change toolholder.

Drive: 1 inch square end DIN 3121 shape H 25,
output: Outer square DIN 3121 - with ball lock.

Quality

Chrome-vanadium special steel.

E Inch	A Inch	D ₂ mm	L mm	L ₁ mm	L ₂ mm	51653	...
1	1	54	96	68	40	#	101

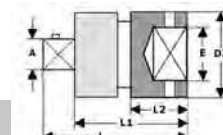

51653



Info

Special tools and custom products

SALTUS®
SOLINGEN - GERMANY

As a certified company, SALTUS® develops and produces, in addition to a comprehensive range of standard tools, customer-specific special tools.

Manufacture follows international standards, samples or diagrams. Be it single-part production or serial production - all SALTUS® products stand out for their extremely narrow tolerances, long tool life and durability.



PRECISION MEETS TECHNOLOGY

