

DIN 69880

B1

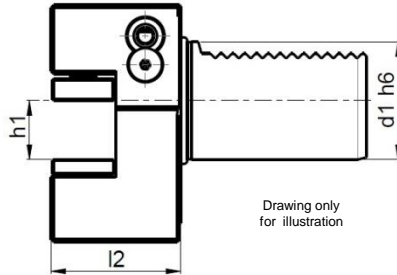

Drawing only for illustration

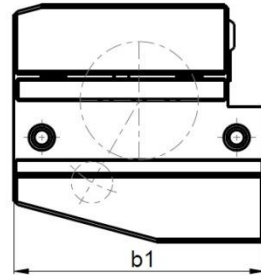

Code	d1	h1	l2	b1
NGT B1-30X20X40	30	16/20	40	70
NGT B1-40X25X44	40	20/25	44	85

DIN 69880

B2

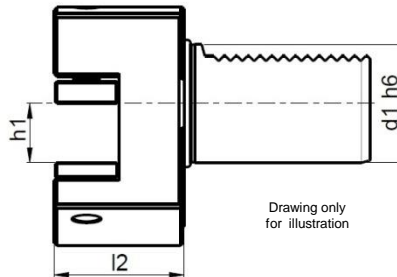

Drawing only for illustration

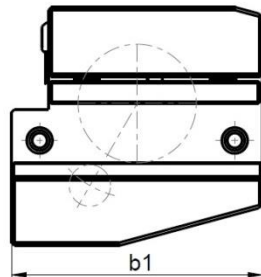

Code	d1	h1	l2	b1
NGT B2-30X20X40	30	16/20	40	70
NGT B2-40X25X44	40	20/25	44	85

DIN 69880

B3

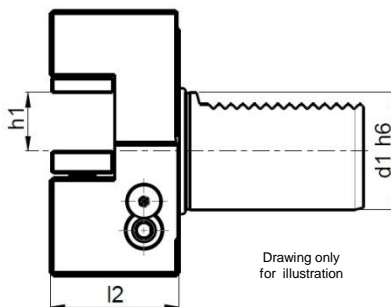
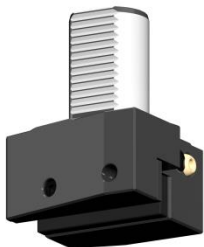

Drawing only for illustration

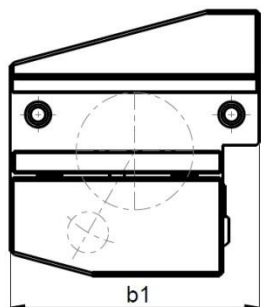

Code	d1	h1	l2	b1
NGT B3-30X20X40	30	16/20	40	70
NGT B3-40X25X44	40	20/25	44	85

DIN 69880

B4

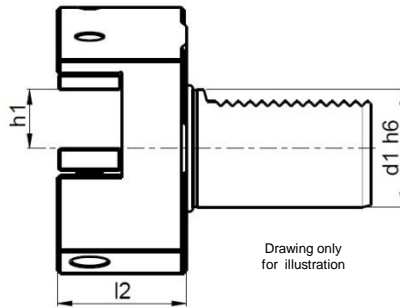
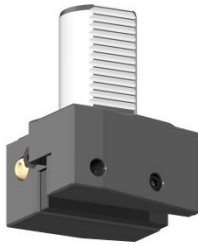

Drawing only for illustration

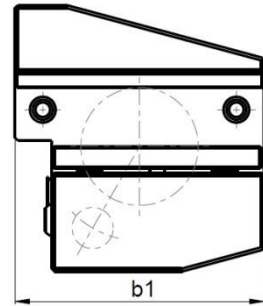

Code	d1	h1	l2	b1
NGT B4-30X20X40	30	16/20	40	70
NGT B4-40X25X44	40	20/25	44	85

DIN 69880

C1

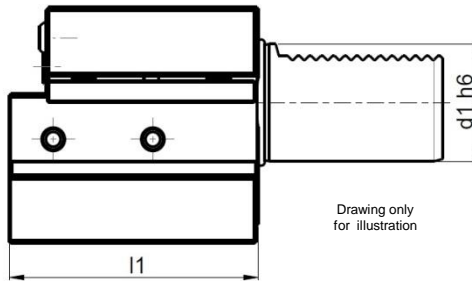

Drawing only for illustration

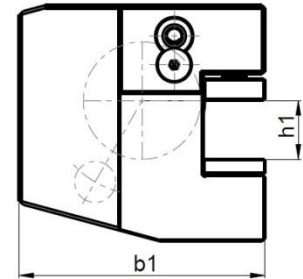

Code	d1	h1	l2	b1
NGT C1-30X20X70	30	16/20	70	70
NGT C1-40X25X85	40	20/25	85	85

DIN 69880

E1

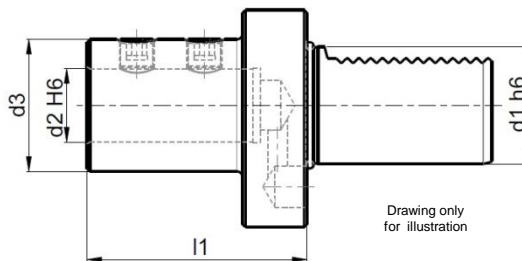

Drawing only for illustration

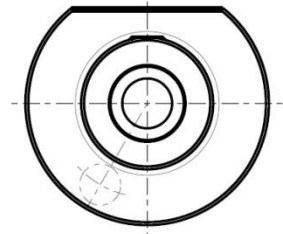

Code	d1	d2	l1	d3
NGT E1-30X25	30	25	71	45
NGT E1-30X32	30	32	75	52
NGT E1-40X25	40	25	75	45
NGT E1-40X32	40	32	75	52
NGT E1-40X40	40	40	90	65

DIN 69880

E2

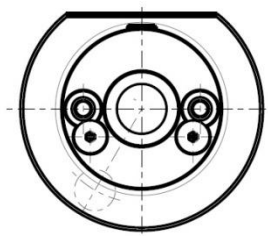
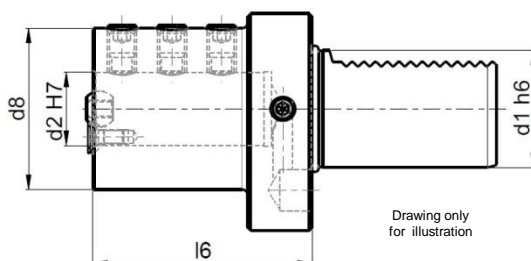

Code	d1	d2	l6	d8
NGT E2-30X10	30	10	60	55
NGT E2-30X12	30	12	60	55
NGT E2-30X16	30	16	60	55
NGT E2-30X20	30	20	60	55
NGT E2-30X25	30	25	60	55
NGT E2-30X30	30	30	60	55
NGT E2-30X32	30	32	75	68
NGT E2-40X7,5	40	7,5	75	55
NGT E2-40X8,5	40	8,5	75	55
NGT E2-40X9	40	9	75	55
NGT E2-40X9,5	40	9,5	75	55
NGT E2-40X10	40	10	75	55
NGT E2-40X11,5	40	11,5	75	55
NGT E2-40X12	40	12	75	55
NGT E2-40X16	40	16	75	55
NGT E2-40X20	40	20	75	55
NGT E2-40X25	40	25	75	55
NGT E2-40X30	40	30	75	55
NGT E2-40X32	40	32	75	83
NGT E2-40X40	40	40	90	83

DIN 69880

E4

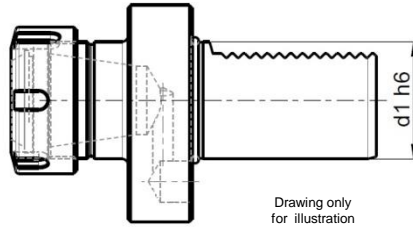

Drawing only for illustration

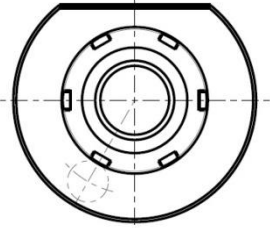

Code	d1	Tool grip
NGT E4-30X25	30	ER25
NGT E4-30X32	30	ER32
NGT E4-40X32	40	ER32
NGT E4-40X40	40	ER40

DIN 69880

F

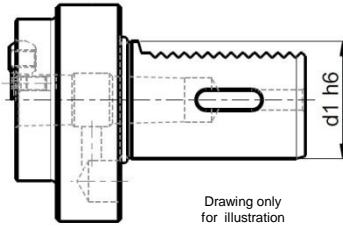

Drawing only for illustration

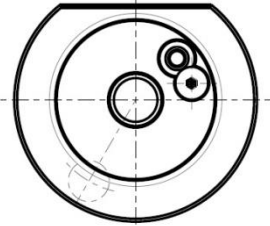

Code	d1	Morse Taper
NGT F40-MT2	40	2
NGT F40-MT3	40	3
NGT F40-MT4	40	4

DIN 69880

**CUT-OFF TOOLHOLDER
HEIGHT ADJUSTABLE, RIGHT**

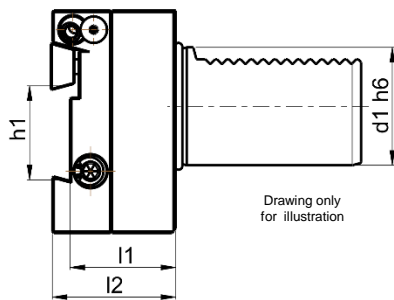
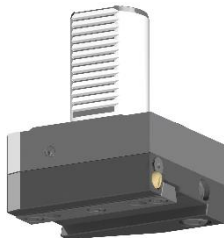

Drawing only for illustration

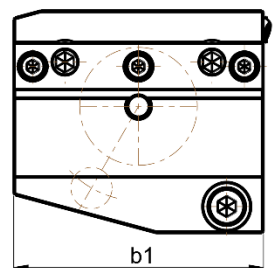

Code	d1	h1	l1	l2	b1
NGT CR-30X26	30	26	36	42	70
NGT CR-40X32	40	32	36	42	85

DIN 69880

BAR PULLER

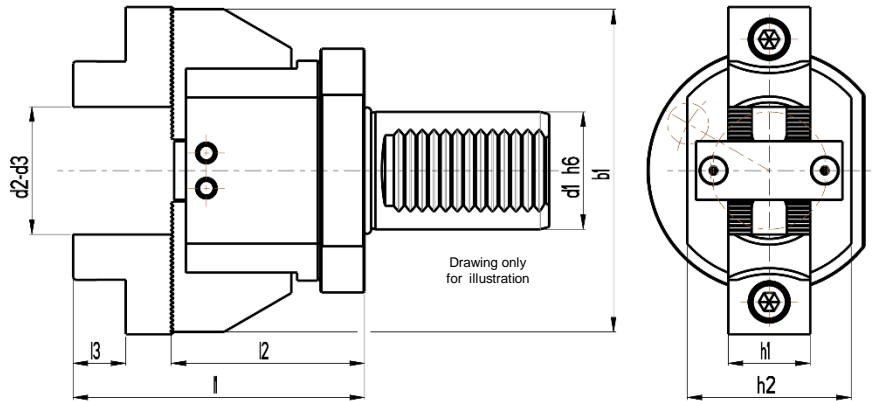
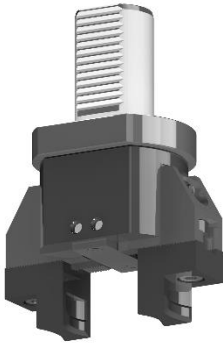

Code	d1	d2	d3	h1	h2	l1	l2	l3	b1
NGT BP-30	30	6-56	56-110	28	56	100	66	18	110
NGT BP-40	40	6-56	56-110	28	56	100	66	18	110