

PowerGuard Fabric Bellows

Ideal for long-life heavy-duty applications.

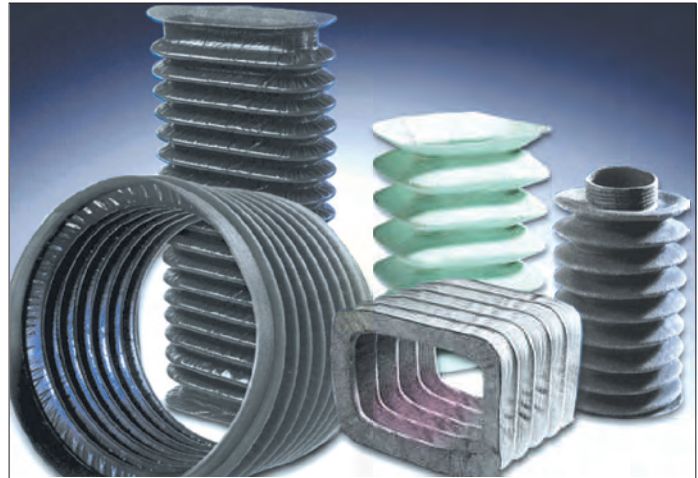

PowerGuard Fabric Bellows have proved their outstanding value in the following conditions:

- ✓ Under heavy mechanical stress
- ✓ At high temperatures (up to 800°C)
- ✓ Exposure to acids and leaches
- ✓ Exposure to ozone and UV radiation.

Possible shapes:

Cylindrical, rectangular, conical, oval.

Available in the following materials:

CR-fabric, carbon fiber, Kevlar (metallized on both sides), PU-or PVC-coated polyester, silicone, leather, FPM.

PowerGuard Fabric Bellows exhibit tremendous dimensional stability. If necessary, **wire rings** and **spring coils** can be incorporated for greater strength.

PowerGuard Fabric Bellows are extremely durable. This is due on the one hand to their high-quality fabric material and on the other to their ingenious production process.

For retrofitting, these bellows can be provided with a **slide fastener** or a **velcro strip**.

Last but not least: *there are no tooling costs!*

Bellows PowerGuard Questionnaire



For preparing the best possible quotation we ask to provide the information requested below:

One-time requirement units Annual requirement units Lot size units

Where do you wish to use the bellows?

Use: horizontal vertical inclined indoor outdoor

Temperature range from -.....°C to +.....°C

Work cycles/min Work hours per day

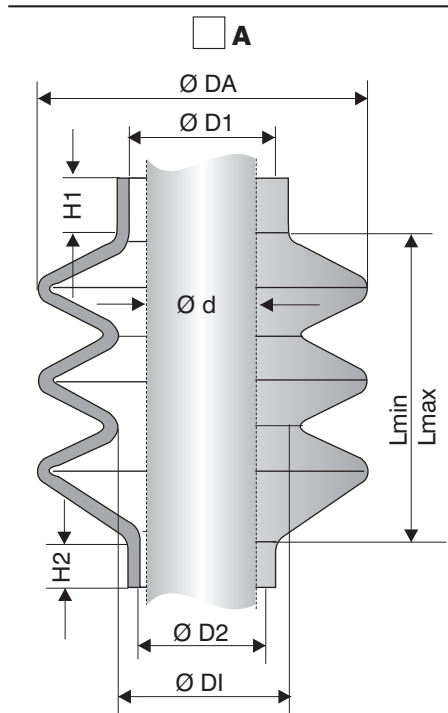

What media will the bellows be exposed to?

	Inside	Outside	Perma- nently	Some- times
<input type="checkbox"/> Dust	<input type="checkbox"/>	<input type="checkbox"/>	<input type="checkbox"/>	<input type="checkbox"/>
<input type="checkbox"/> Water	<input type="checkbox"/>	<input type="checkbox"/>	<input type="checkbox"/>	<input type="checkbox"/>
<input type="checkbox"/> Oil/Grease, namely	<input type="checkbox"/>	<input type="checkbox"/>	<input type="checkbox"/>	<input type="checkbox"/>
<input type="checkbox"/> Acid, namely	<input type="checkbox"/>	<input type="checkbox"/>	<input type="checkbox"/>	<input type="checkbox"/>
<input type="checkbox"/> Leaches, namely	<input type="checkbox"/>	<input type="checkbox"/>	<input type="checkbox"/>	<input type="checkbox"/>
<input type="checkbox"/> Spatters	<input type="checkbox"/>	<input type="checkbox"/>	<input type="checkbox"/>	<input type="checkbox"/>
<input type="checkbox"/> Pressure bar	<input type="checkbox"/>	<input type="checkbox"/>	<input type="checkbox"/>	<input type="checkbox"/>

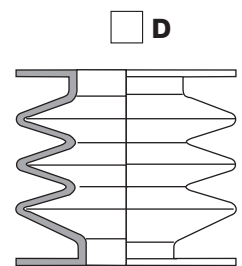
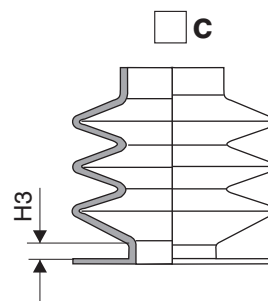
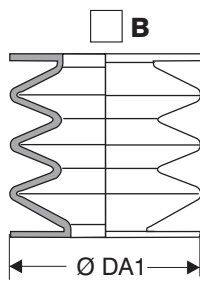

! Please tick the desired type and specify the dimensions.

d mm	DI mm
Lmin mm	DA mm
Lmax mm	DA1 mm
D1 mm	H1 mm
D2 mm	H2 mm
	H3 mm

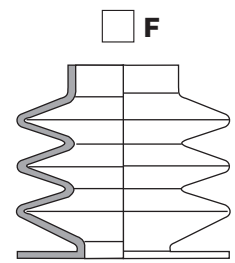
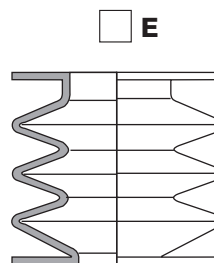

On request: Zipper Velcro Air vents

Company:
 Your name:
 Address:
 Postal code/City:
 Country:

Phone:
 Fax:
 eMail:
 www:

