

CUTTING TOOLS & TOOL HOLDERS

Nine⁹®

www.jic-tools.com.tw

Cat. 15 







Productivity & Creativity & Infinity

Awarded Patents in

Taiwan
USA
Japan
Germany
China



You will be interested to know that we have just introduced our new De-B & X060 engraving tool

Page

60



NC De-Burring

- ▶ Insert has 6 flutes, capable of running 6 times higher feedrate
- ▶ Smallest countersink 0.5mm
- ▶ High feed rate for high speed de-burring on CNC machines
- ▶ Indexable type ensures the relative position of de-burring.

Engraving X060

- ▶ Minimum width of bottom of groove : 0.1mm
- ▶ Angles from 10° up to 120°
- ▶ Replace solid carbide engraving tool

Drilling Tool

Page
57



Contents >>



Page **09**
NC Spot Drill



Page **41**
i - Center



Page **51**
Engraving Tool



Page **63**
Chamfer Mill

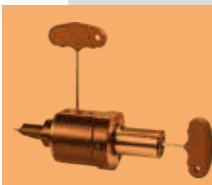
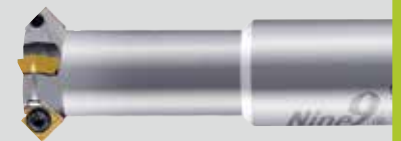

Page **68**
Accessories

- ▶ DC Slim Chuck
- ▶ Extension Bar
- ▶ ISO 20/25 Tool Holder
- ▶ Center Height Adjusting Sleeve

NEW



Website
NC Helix Drill



The Winner is not necessarily
the one who runs the fastest
but the one who holds on to the last



Nine9 company began in 1994 and with the development of special tools, NC spot drills, super power drills, boring tools and engraving tools.

The Nine9 logo was commissioned in 1999.

It comes from the Chinese characters meaning "long life and durability" – words which aptly describe all Nine9 tools.

99 is the largest 2 digit number, indicating maximum product endurance.



Time Saving

We have invested resources in the design & Manufacture of inserted cutters. Indexable insert eliminates the tool's changing time.



Long Tool Life

Nine9 Insert geometry, grades and coating are specifically engineered to extend tool life. It improves productivity and competitive capability in a wide range of industries.



Cost Saving









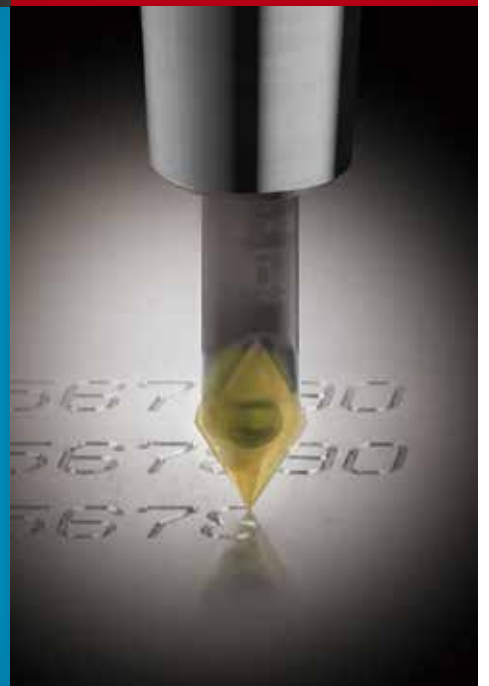









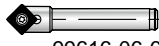







Multi-functional or interchangeable tooling system is designed to benefit users of machining, CNC lathes.....

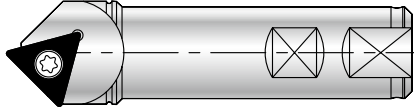

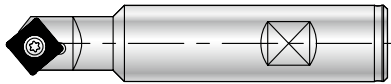

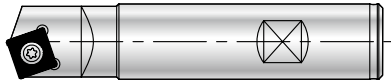
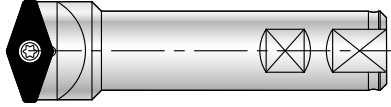

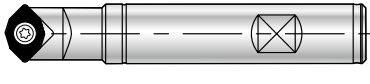







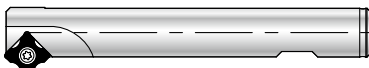







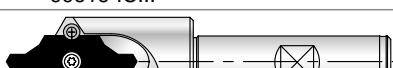





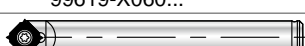

Highly Efficient

Our outstanding R&D capabilities combined with fast delivery provide a strong competitive edge.

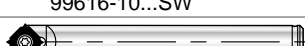

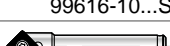
Angle	Holder	Inserts	D min.	D max.	Spotting	Chamfering	Grooving	Engraving	Drilling	Page
NC Spot Drill										
60°	 99616-09V	 V9MT0802	1	9	•	•	•	• Tmin=0.1		16
	 99616-13V	 V9MT12T3	2	13	•	•	•	• Tmin=0.1		16
82°	 99619-V082-3/8	 V0820802	2	9	•	•	•	• Tmin=0.1		17
	 99619-V082-5/8	 V08212T3	2	14	•	•	•	• Tmin=0.1		17
90°	 99616-06-6...	 N9MT05T1	1	6	•	•		• Tmin=0.1		18
	 99616-10...	 N9MT0802	2	10	•	•	•	• Tmin=0.1		19
	 99616-10-M5									
	 99616-14...	 N9MT11T3	3	14	•	•	•	• Tmin=0.1 (2 Cutting edges)		21
	 99616-14-M8							• Tmin=1.0 (4 Cutting edges)		
	 99616-22	 N9MT1704	3	22	•	•	•			23
	 99616-25-CT28	 N9MT2204	4	25	•	•				24
100°	 99616-20-100		3	16	•	•				
120°	 99616-20-120	 N9MT11T3	3	17	•	•				25
142°	 99616-20-142...		3	18	•	•				
	 99619-V142...	 V1421604	2	32	•					27
145° + 90°	 99616-10 / 14 / 22 ...	 WSP / M4-M16	3.3	20	•	•	•			13

Angle	Holder	Inserts	D min.	D max.	Spotting	Chamfering	Grooving	Engraving	Drilling	Page
Corner Rounding										
	 99616-06...99616-14...RC	 N9MT05/N9MT11..RC (2 Cutting edges)	R0.5 R1.0	R1.0 R3.0		•				31
	 99616-22...RC	 N9MT1704RC (2 Cutting edges)	R4.0	R6.0		•				33
	 99616-16-25R		R1.0	R3.0		•				34
	 99616-16-30R	 N9MT11T3R (4 Cutting edges)				•				
	 99616-16-40R					•				
Large 45° Chamfering										
45°	 99616-18	 N9MT11T308LA	6	18		•				36
	 99616-28						•	*	*Side grooving	
Center Drilling / i-Center										
	 99616-IC...	 DIN332 Form R	1.0	10					•	43
60° + 120°	 99616-IC...	 DIN332 Form A+B	1.0	10					•	
60°	 99616-IC...	 ANSI 60°	5/64"	3/8"					•	
Engraving Tools										
45°	 99619-V045...	 V04506T1W	0.45	2.1		•		•		53
60°	 99619-V060...	 V06006T1W	0.25	2.7		•		•		54
10° / 120°	 99619-X060...	 X060A	0.10	2.7				•		57
60°	 99616-10...SW	 N9MT0802	0.25	1.1		•		•		12
90°	 99616-10...SW	 N9MT0802	0.25	2.0		•		•		12
	 99616-06-6	 N9MT05T1	1	6		•	•	•		18



Inserts >> Quick Pick

Nine9 inserts apply for modern machining by its special geometry which is able to run at higher speed and feed. In addition, the indexable insert eliminates the tool's changing time. Carbide insert with latest coating technology extends tool life dramatically. Nine9 insert helps you to save money and increase productivity.

Products	Grade	Coating	P Steel	M Stainless Steel	K Cast Iron	N Non-Ferrous	H Hardened Steel Up to 56 HRC	S Titanium
NC Spot Drill	NC10	TiAlN		●	●	◎		
	NC40	TiN	●	○	◎			
	NC2071	TiN	●	◎	○	◎		
	NC9076	DLC		◎		●		◎
	NC60	Cermet	◎				●	
Corner Rounding	NC2071	TiN	●	○	●			
	NC9036	DLC		●		●		◎
i-Center	NC2033	TiAlN	●	○	●		○	
Engraving	NC2032	TiAlN	●	○	●			
	NC2071	TiN	◎	●		◎		
	NC9031	TiN		◎		●		
	NC2035	ALDURA	◎		○		●	
	NC9036	DLC		◎		●		◎
Chamfer Mill	NC2032	TiAlN	●	○	●		◎	
	NC9071	TiN	○	●		●		

● Best ◎ Suit ○ Possible



Features

Universal grade for non-ferrous metal, cast iron and stainless steel.
General purpose, fully ground cutting edge and relief angle.

Universal grade for all unhardened steel, and tool steel up to 1200N/mm²
General purpose, fully ground cutting edge and relief angle .

Universal grade for all unhardened steel, free cutting steel and tool steel up to 750N/mm²
The cutting geometry has been designed to optimize the tool's performance and to use in high speed machining.

For non-ferrous material such as aluminum, acrylic, brass, copper, titanium and long cutting chip materials.
High positive geometry and sharp edge produces excellent surface finish.

For hardened steel up to 56HRC.
Cermet insert reduces heat and low tool wearing at the cutting edge.

Universal grade for all unhardened steel and cast iron.
The cutting geometry has been designed to optimize the tool's performance.

For non-ferrous material, aluminum, acrylic, brass, cooper, stainless steel (low carbon contain) and titanium.
High positive geometry and sharp edge produces excellent surface finish.

For carbon steel, alloy steel, high alloy steel and cast iron.
2 Cutting flutes design same as carbide center drill for high performance speed and feed rate.

For all kind of steel from 30~50 HRC, carbon steel, alloy steel and cast iron.
TiAlN coating provides a longer tool life.

Universal grade for all kind of steel<30 HRC, non-ferrous metal and stainless steel.
The cutting geometry of this insert has been designed with strong cutting edge.

For non ferrous metal, aluminum, brass, copper, plastic, acrylic and stainless steel.
Very sharp edge for shallow engraving.

For steel with heat treatment up to 56 HRC.
Latest ALDURA coating to reduce heat and tool wear.

For non-ferrous material and titanium.
Very sharp edge for shallow engraving.

For carbon steel, alloy steel, cast iron and hardened steel up to 56 HRC.
Upgraded AlTiN coating provides a very long tool life.

For non-ferrous metal, aluminum, al-alloy, brass, copper and stainless steel.
Very sharp produces excellent surface finish.



No Need To Choose Nine9 Does It All! >>



Cost Saving



Time Saving



Highly Efficient



Long Tool Life

► Various inserts can fit on same holder

► Various Applications

► Spotting

► Corner Rounding

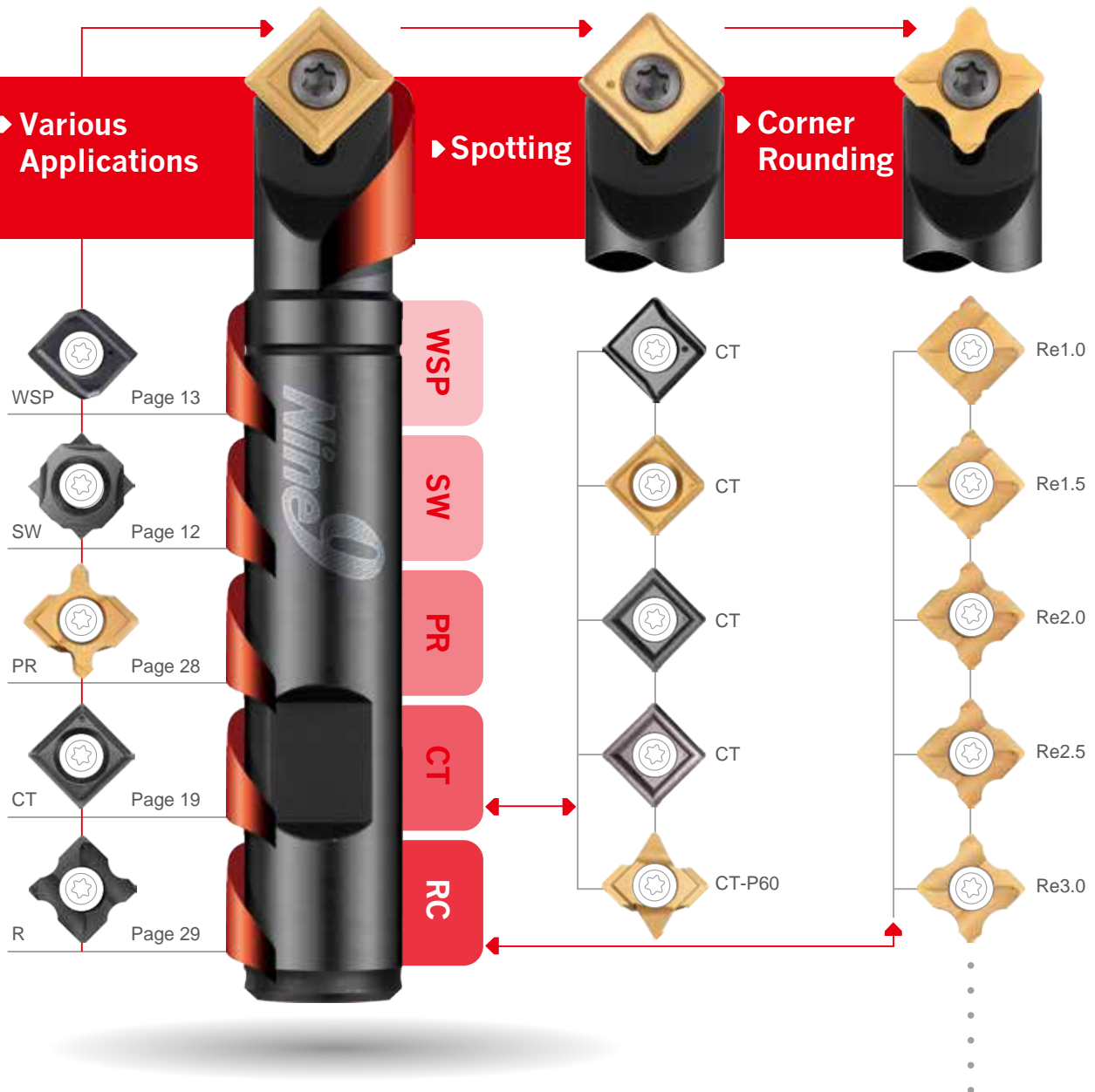

A Center drilling

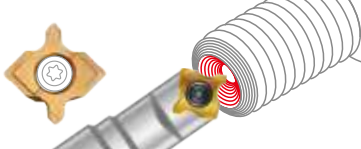

B G Corner rounding

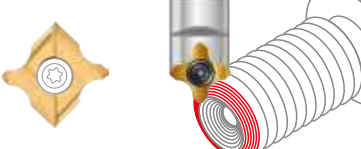

C Thread turning

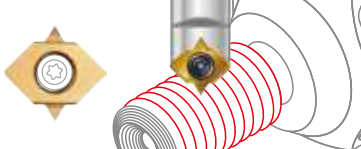

D Gooving

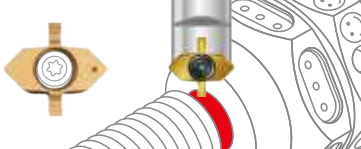

E Taper turning

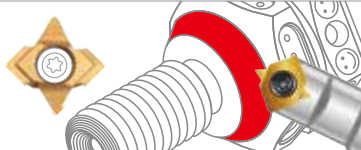

F V-grooving

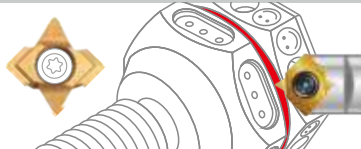

H Engraving



I Center drilling

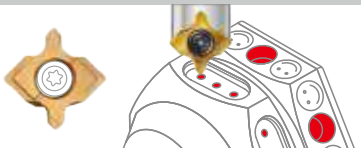

J Face milling



K Drilling & milling a groove



Now Future



▲ Multifunctional Cutting Tool

- Universal, easy handling and material saving!
- One holder to cover multiple applications!



NC Spot Drill >>

NC Spot Drill with indexable carbide insert.

High efficiency! Low cost!

CNC lathes, CNC turning centers and machining centers.

Features

- ▶ Spotting produces better hole position and geometrically uniform holes
- ▶ Available shank diameter-Ø5, Ø6, Ø10, Ø12, Ø16, Ø20mm, Ø3/8", Ø1/2", Ø5/8", Ø3/4", M5, M6, M8
- ▶ One tool will perform multiple applications
 - Long tool life.
 - Each insert has 2 cutting or 4 cutting edges.
 - Suitable for spotting, chamfering, grooving and engraving.
 - 45° / 60° / 82° / 90° / 100° / 120° / 142° angle for different applications.
 - Increase cutting speed with coated carbide inserts.



- ▲ Machining Center
- a** Engraving
 - b** Spotting
 - c** Chamfering
 - d** Grooving

▼ ALL IN ONE!!

Spotting

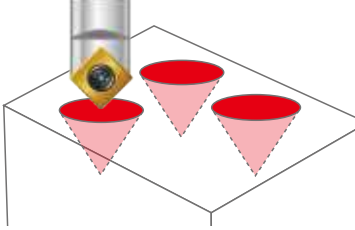

Chamfering

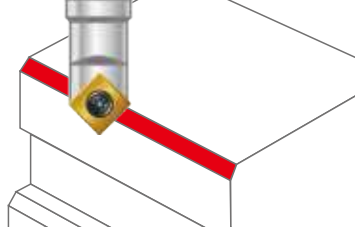

Grooving

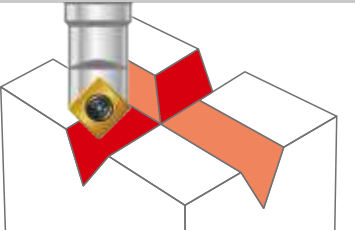

Engraving



W Spotting

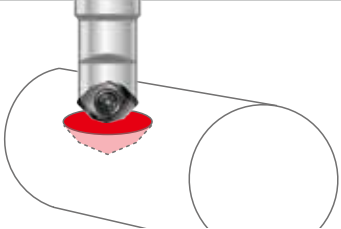

Corner Rounding

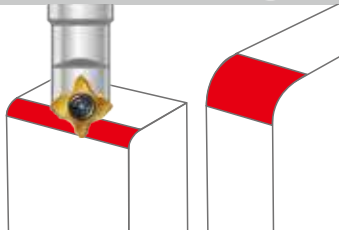

- ▲ CNC Lathes
- a** External and internal chamfering
 - b** Grooving
 - c** Centering
 - d** Facing

A New Drilling Concept!

► 0.5xD of spotting >>

Many drill manufacturers and suppliers state that their drills start drilling on the solid material. You can look forward to the following benefits when using the NC Spot Drill to drill a spot that is half of the drilling diameter.

► Drill Benefits >>

- Higher feed rate.
Why? Because the drill is guided at the strongest part of cutting edge.
- Better center position.
Why? Because the spotting is done by a single cutting edge which is out of center, and similar to boring operation.
- Increased tool life.

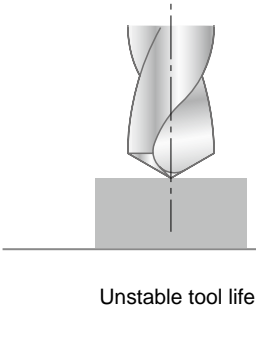
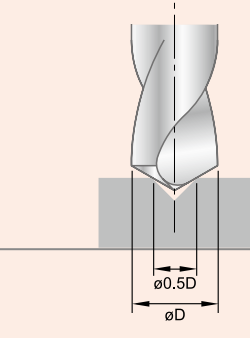
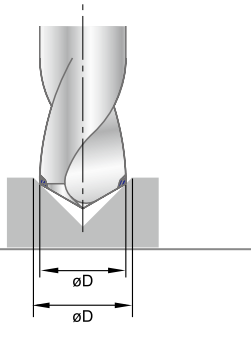
NC Spot Drill	Without Spotting	0.5xD Spotting	Larger Spotting
<ul style="list-style-type: none"> • Better center position! • Longer tool life! 	<ul style="list-style-type: none"> • Drill has less position accuracy and diameter tolerance. 	<ul style="list-style-type: none"> • Best result! • Higher speed and feed rate. • Better position accuracy and diameter tolerance. 	<ul style="list-style-type: none"> • Longer spotting time! • Guided at the weakest corner of drill. • Shorter tool life
			
	✗	○	✗

► Various Applications of NC Spot Drill >>

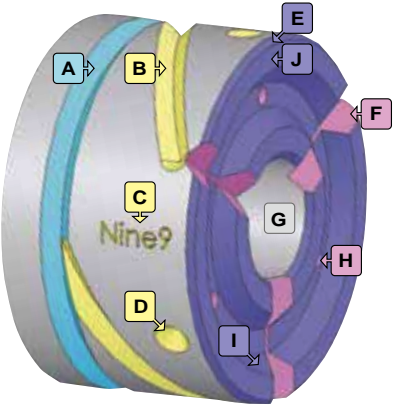
Turning Center	Fig	Applications	Multifunctional Cutting Tool
	A	Grooving	<p>Use on CNC lathes CNC turning centers Machining centers Milling machines SPM macines</p>
	B	Helical groove milling	
	C	Engraving	
	D	Spot drilling	
	E	Chamfer turning	
	F	Face groove milling	
	G	Internal turning	
	H	Spot drilling on end surface	
	I	Internal Chamfering	
	J	Facing grooveing	

N9MT080201W Engraving



▶ Inserts >>

- No need to reset tool length after changing insert or cutting edge.
- Each insert has 4 cutting edges.

- NC10:** • Universal grade for non-ferrous metal and cast iron.
- NC40:** • Universal grade for all unhardened steel.
- 60-NC40:** • Very positive angle for 60° engraving for all kind of unhardened steel and cast iron.

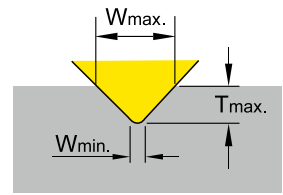

Code	Parts No.	Angle	Grade	Coating	Image	Dimensions		Wmin.	Wmax.	Tmax.
						L	S			
013404	N9MT080201W-60-NC40	60°	K20F	TiN		8	2.38	0.1	1.1	0.8
013405	N9MT080201W-NC40	90°	K20F	TiN		8	2.38	0.1	2.0	0.9
013406	N9MT080201W-NC10	90°	K20F	TiAlN		8	2.38	0.1	2.0	0.9

▶ Holder >>

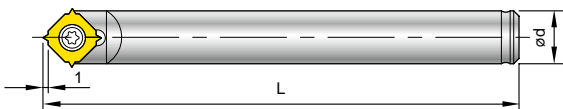

Code	Parts No.	Ød	L	Screw	Key
603001	00-99616-10	10	90	NS-30055 2.0 Nm	NK-T8
613001	00-99616-3/8	3/8"	90		

▶ Mini Spotting >>

- Engraving inserts can be used for small diameter spotting.
- *Best positioning accuracy!
- *Better surface with spotting by NC Spot Drill in advance.

Tool / Insert	Spindle Speed / Feed Rate	With Spotting	Without Spotting
99616-10 + N9MT080201W NC40	S 3,000 25,000 r.p.m.		
	f 0.01 0.02 mm/rev.		

W Spotting New Geometry of Spotting Tool

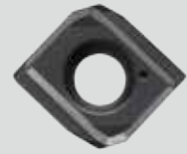

NC2033

► Combined spotting and chamfering 145° + 90° >>

- Reduces process to one operation. Shortens cycle time.
- Use to spot prior to drilling with high performance drills for higher accuracy of hole position.

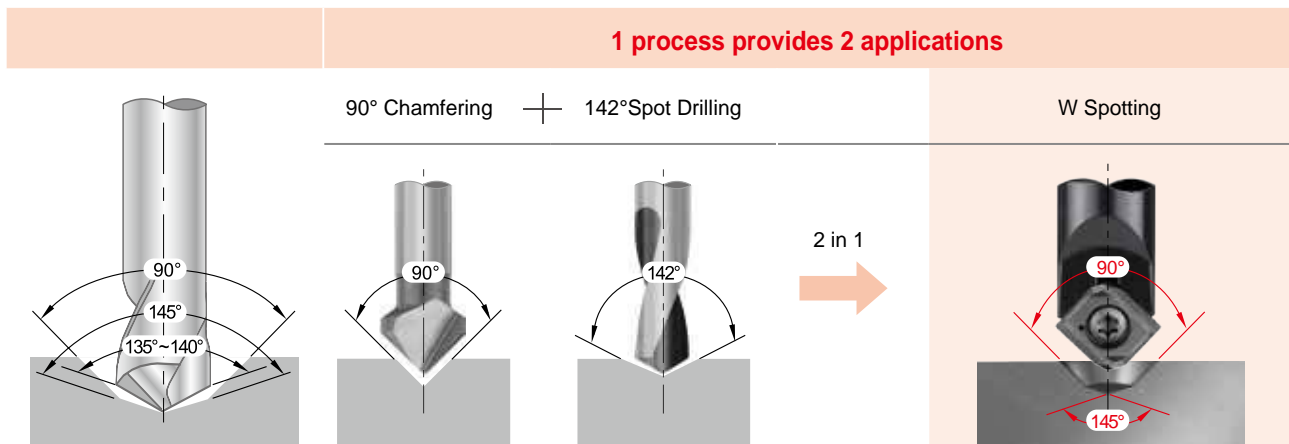

► Inserts >>

- NC2033:**
- Fully ground cutting edge and relief angle.
 - Universal grade for steel and cast iron.
 - Each insert has 2 cutting edges.

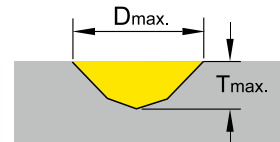

Code	Parts No.	Grade	Coating		Thread Size	*D1±0.05	D2	L2	Dmax.	Tmax.
013203	N9MT0802M04C-NC2033				M4x0.7	3.30	4.20	0.93		2.83
013204	N9MT0802M05C-NC2033	K20F	TiAlN		M5x0.8	4.20	5.25	1.14	8	2.52
013205	N9MT0802M06C-NC2033				M6x1.0	5.00	6.30	1.39		2.24
014219	N9MT11T3M08C-NC2033	K20F	TiAlN		M8x1.25	6.80	8.40	1.81	13	4.11
014220	N9MT11T3M10C-NC2033			M10x1.5	8.50	10.50	2.28	3.53		
014221	N9MT11T3UNC25-NC2033				1/4-20 UNC	5.08	6.70	1.55		4.70
014222	N9MT11T3UNC31-NC2033	K20F	TiAlN		5/16-18 UNC	6.53	8.40	1.90	13	4.20
014223	N9MT11T3UNC38-NC2033				3/8-16 UNC	7.94	10.00	2.22		3.72
016205	N9MT1704M12C-NC2033				M12x1.75	10.25	12.60	2.91		6.61
016206	N9MT1704M14C-NC2033	K20F	TiAlN		M14x2.0	12.00	14.70	3.22	20	5.87
016207	N9MT1704M16C-NC2033				M16x2.0	14.00	16.80	3.51		5.11

Note: * D1 refer to the Tap Pre-drilling sizes.
 * Technical information, please refer to page 39.

W Spotting New Geometry of Spotting Tool



► Holder >>

- Utilizes standard **NC Spot Drill** holders.
- Holders and inserts are interchangeable.
- Applications: Spotting, grooving and chamfering.

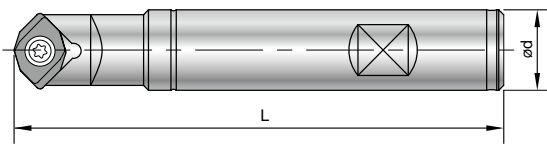

Code	Parts No.	Ød	Insert Type	Thread Size	L	Screw	Key
603001	00-99616-10	10	N9MT0802	M4~M6	89.08±0.29	NS-30055 2.0Nm	NK-T8
613001	00-99616-10-3/8	3/8"					
604004	00-99616-14	16	N9MT11T3	M8~M10	97.55±0.55	NS-35080 2.5Nm	NK-T15
614002	00-99616-14-5/8	5/8"		1/4~3/8 UNC			
606001	00-99616-22	20	N9MT1704	M12~M16	96.24±0.64	NS-50125 5.5Nm	NK-T20
616001	00-99616-22-3/4	3/4"					

► Example >>

- The recommended chamfering is 5% of the nominal diameter of the thread, for example 6.3 mm for M6 thread.
- If you need larger chamfer, it can be calculated the required depth of spotting. (see page 39)

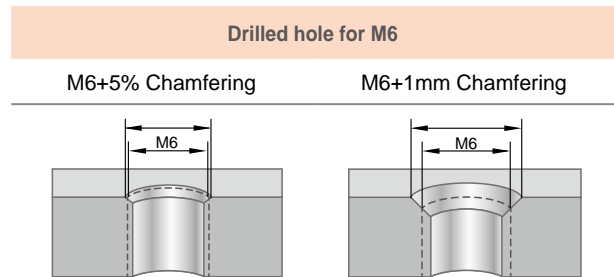

► Comparison >>

Carbide Step Drill	Spotting + Drill	W Spotting + Drill
<ul style="list-style-type: none"> • Tool cost is high • Shorter tool life • Can't drill directly from solid on round parts. Bad position accuracy. 	<ul style="list-style-type: none"> • Longer drilling time • Guided at the weakest corner of drill • Shorter tool life 	<ul style="list-style-type: none"> • Shorter drilling time • Guided at the strongest corner of drill • Longer tool life • Also for chamfering or grooving application

N9MT11T3P60

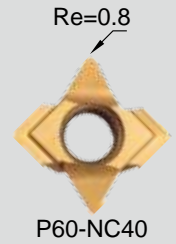

▶ Inserts >>

- Fully ground spotting insert, for 60 degree spotting and engraving.
- NC40:**
 - Universal grade for all unhardened steel and cast iron.
 - Each insert has 2 cutting edges.

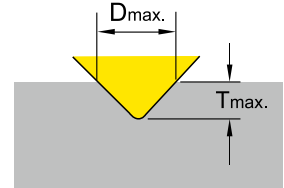

Code	Parts No.	Grade	Coating	Image	Dimensions			Dmax.	Tmax.
					L	S	Re		
014204	N9MT11T3P60-NC40	P35	TiN		11	3.97	0.8	6.2	4

▶ Holder >>

- A single cutting edge design creates higher precision and position when spotting.
- Applications: For spotting, engraving, small grooving on milling machines, machining centers.

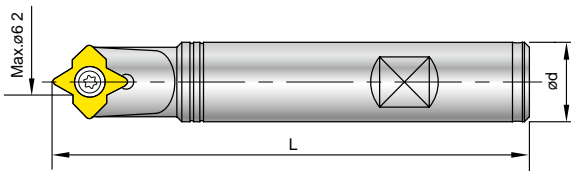

Code	Parts No.	Ød	L	Screw	Key
604002	00-99616-14-12	12	100	NS-35080 2.5 Nm	NK-T15
604004	00-99616-14	16	100		

V9MT0802 / V9MT12T3

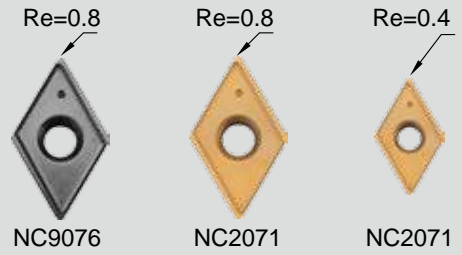

▶ Inserts >>

- 60 degree indexable spotting insert, Dmax 13mm.
- Special geometry with supporting edges for using in high speed machining.
- Excellent tool for grooving. Saving machining time!

- NC9076:**
- For non-ferrous material such as aluminum, al-alloy, titanium brass, copper and long cutting chip metal.
 - Produces excellent surface finish on non-ferrous metal.
 - Each insert has 2 cutting edges.

- NC2071:**
- Universal grade for all unhardened steel and cast iron.
 - Each insert has 2 cutting edges.

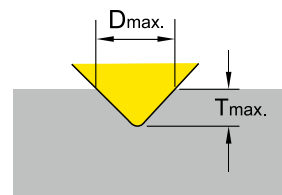

Code	Parts No.	Grade	Coating	Image	Dimensions			Dmax.	Tmax.
					L	S	Re		
019201	V9MT0802CT-NC2071	K20F	TiN		8	2.38	0.4	9	7.3
015201	V9MT12T3CT-NC2071	K20F	TiN		12.7	3.97	0.8	13	10.3
015202	V9MT12T3CT-NC9076	K20F	DLC						

▶ Holder >>

- A single cutting edge creates higher precision and position when spotting.
- Applications:
 - Spotting, engraving, grooving and chamfering on milling machines, machining centers.
 - Spotting, facing on CNC Lathes.

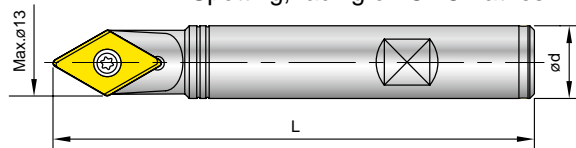

Code	Parts No.	Insert Type	Ød	L	Screw	Key
609001	00-99616-09V	V9MT08	8	60	NS-25045 1.2Nm	NK-T7
605001	00-99616-13V	V9MT12	16	100	NS-35080 2.5 Nm	NK-T15
615001	00-99616-13V-5/8		5/8"	100		

NC Spot Drill

V0820802 / V08212T3

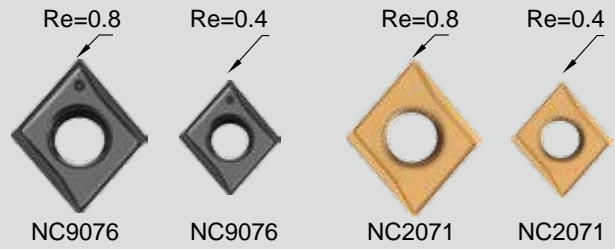
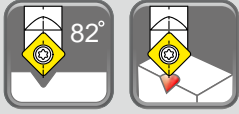

► Inserts >>

- 82 degree indexable spotting insert, Dmax 14mm (0.551")
- Match the geometry of American standard flat head screw hole.
- Special geometry with supporting edges for use in high speed machining.

- NC9076:**
- For non-ferrous material such as aluminum, al-alloy, titanium brass, copper and long cutting chip metal.
 - Produces excellent surface finish on non-ferrous metal.
 - Each insert has 2 cutting edges.

- NC2071:**
- Universal grade for all unhardened steel and cast iron.
 - Each insert has 2 cutting edges.

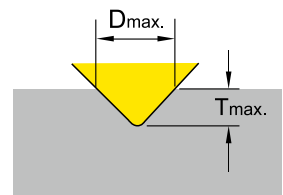

Code	Parts No.	Grade	Coating	Re	Dimensions			Dmax.	Tmax.
					L	S	Re		
0108201	V0820802-NC2071	K20F	TiN		8	2.38	0.4	9 (0.354")	4.8 (0.189")
0108202	V0820802-NC9076	K20F	DLC		12.7	3.97	0.8	14 (0.551")	7.5 (0.295")
0108211	V08212T3-NC2071	K20F	TiN						
0108212	V08212T3-NC9076	K20F	DLC						

► Holder >>

- Special cutting edge design gives higher precision and position when spotting.
- Applications : • Spotting, engraving, grooving and chamfering on milling machines, machining centers.
- Spotting, facing on CNC Lathes.

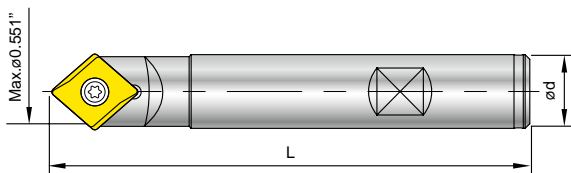

Code	Parts No.	Insert Type	Ød	L	Screw	Key
693001	00-99619-V082-3/8	V0820802	3/8"	90	NS-30055 2.0 Nm	NK-T8
693002	00-99619-V082-5/8	V08212T3	5/8"	100	NS-35080 2.5 Nm	NK-T15

N9MT05T1

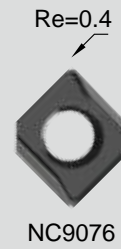
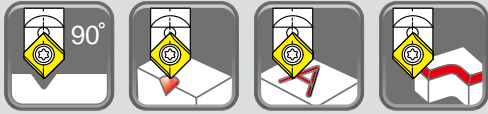

▶ Inserts >>

- Mini spotting drill with indexable insert, low cutting power required.
- Especially good for Swiss type automatic lathes and CNC lathes.
- NC9076:**
 - For non-ferrous material such as aluminum, titanium, brass, copper and stainless steel.
 - Produces excellent surface finish on non-ferrous metal.
 - Each insert has 2 cutting edges.
- NC2071:**
 - Universal grade for all unhardened steel and cast iron.
 - Geometry with supporting edges to stabilize the cutting condition on low power machine.
 - Each insert has 2 cutting edges.

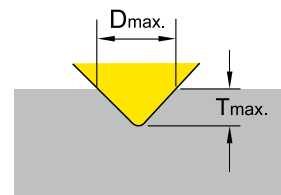

Code	Parts No.	Grade	Coating	Re	Dimensions			Dmax.	Tmax.
					L	S	Re		
011201	N9MT05T1CT-NC2071	K20F	TiN		5	1.8	0.4	6	2.8
011202	N9MT05T1CT-NC9076	K20F	DLC						

▶ Holder >>

- Smallest indexable spotting drill holder.
- Single cutting edge design gives higher precision when spotting.
- Applications :
 - Spotting, engraving, and chamfering on milling machines, machining centers.
 - Spotting, facing on CNC Lathes.

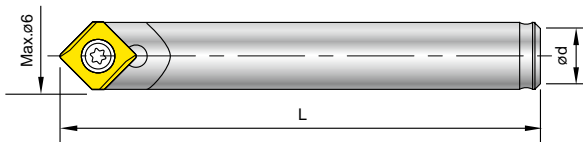

Code	Parts No.	Ød	L	Screw	Key
601001	00-99616-06-6	6	35		
601002	00-99616-06-5	5	35	NS-20036 0.8 Nm	NK-T6
601003	00-99616-06-6L	6	60		

Note:601003 is carbide shank holder.

N9MT0802

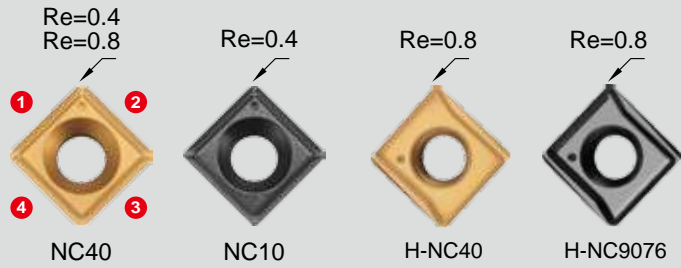
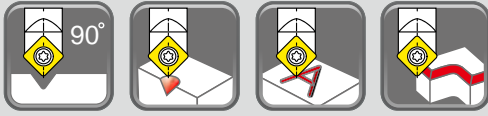

▶ Inserts >>

- NC40:**
 - General purpose, universal grade for all unhardened steel.
 - Each insert has 4 cutting edges.
- NC10:**
 - High positive angle and fully ground cutting edge and relief angle.
 - Universal grade for non-ferrous metal, cast iron and stainless steel.
 - Each insert has 4 cutting edges.
- H-NC40:**
 - Best choice for spotting application.
 - Special geometry with supporting edges for use in high speed machining.
 - Universal grade for all kind of steel and cast iron.
 - Each insert has 2 cutting edges.
- H-NC9076:**
 - High positive geometry and sharp edge.
 - For non-ferrous material such as aluminum, titanium, brass, copper and long cutting chip metal.
 - Produces excellent surface finish on non-ferrous metal.
 - Each insert has 2 cutting edges.

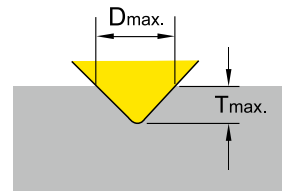

Code	Parts No.	Grade	Coating	Re	Dimensions			Dmax.	Tmax.
					L	S	Re		
013401	N9MT080208CT-NC40	K20F	TiN	0.8	8.31	2.38	10	4.5	
013402	N9MT080204CT-NC40	K20F	TiN	0.4	8.31	2.38			
013403	N9MT080204CT-NC10	K20F	TiAlN	0.4	8.31	2.38			
013201	N9MT0802CT2T-H-NC40	K20F	TiN	0.8	8.31	2.38			
013202	N9MT0802CT2T-H-NC9076	K20F	DLC	0.8	8.31	2.38			

▶ Holder >>

- Single cutting edge design gives higher precision when spotting.
- Applications :
 - Spotting, engraving, grooving and chamfering on milling machines, machining centers.
 - Spotting, facing, turning on CNC Lathes.

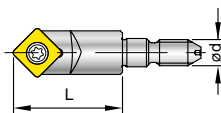
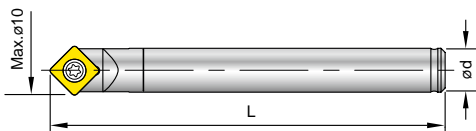

Code	Parts No.	Ød	L	Screw	Key
603001	00-99616-10	10	90		
603003	00-99616-10-SL10	10	90		
613001	00-99616-10-3/8	3/8"	90	NS-30055 2.0 Nm	NK-T8
623001	00-99616-10-M5	M5	25		
623002	00-99616-10-M6	M6	25		

Note: • 603003 with side lock flat on shank.
 • Nine9 extension bar for M5,M6 screw fit holder, see page 68.

N9MT0802

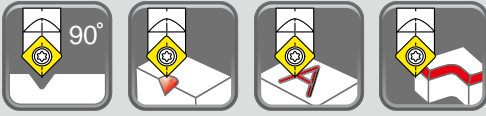

► Single Set >>

- User friendly, each set is fitted with one complimentary insert.

Code	Parts No.	Ød	Total Length	Insert fitted	Dmax.	Tmax.
603101-3401	00-99616-10-02S	10	90	N9MT080208CT-NC40	10	4.5
603101-3403	00-99616-10-02SAL	10	90	N9MT080204CT-NC10	10	4.5

► Starter Package >>

- Selected package for starter who wants to try NC Spot Drill.
- Included one insert on tool holder and five inserts in the pocket.
- Total 6 inserts are equal to 24 spot drills.

Code	Parts No.	Ød	Insert included	Content
603201-3401	00-99616-10-ME6	10	N9MT080208CT-NC40	1 tool holder + 6 inserts + 1 key
603201-3403	00-99616-10-ME6AL	10	N9MT080204CT-NC10	
613201-3401	00-99616-10-IN6	3/8"	N9MT080208CT-NC40	
613201-3403	00-99616-10-IN6AL	3/8"	N9MT080204CT-NC10	

► Comparison >>

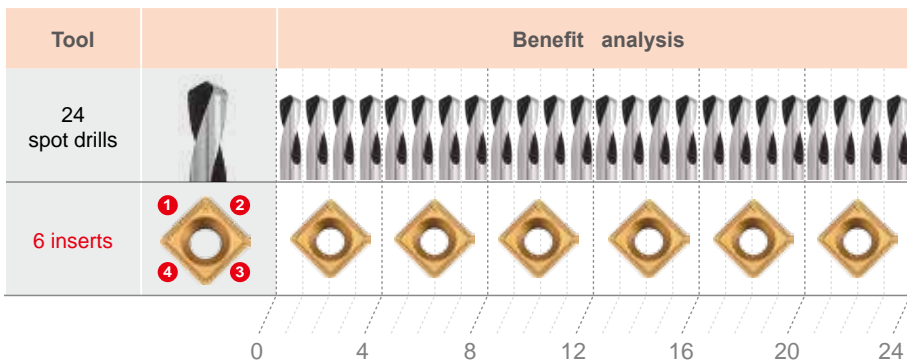

Low Cost! Economy!

6 inserts
 12 inserts
 24 inserts
 ...

24 spot drills
 48 spot drills
 96 spot drills
 ...

6 inserts = 24 spot drills

N9MT11T3

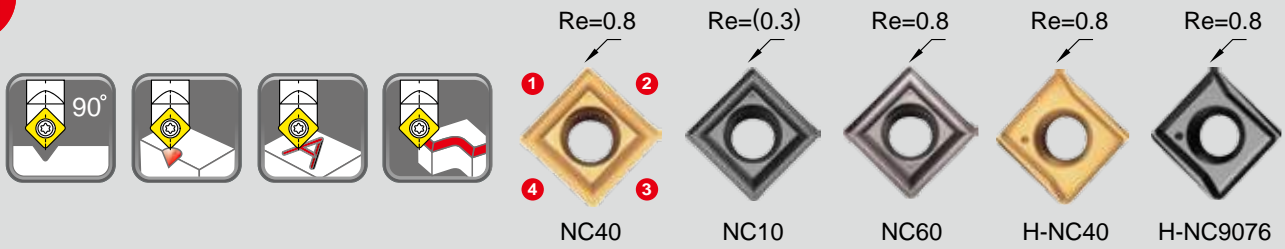

► Inserts >>

- NC40:**
 - General purpose, universal grade for all unhardened steel.
 - Each insert has 4 cutting edges.
- NC10:**
 - High positive angle and fully ground cutting edge and relief angle.
 - Universal grade for non-ferrous metal, cast iron and stainless steel.
 - Each insert has 4 cutting edges.
- NC60:**
 - Cermet insert, for hardened steel up to HRC56 .
 - Each insert has 4 cutting edges.
- H-NC40:**
 - Best choice for spotting application.
 - Special geometry with supporting edges for use in high speed machining.
 - Universal grade for all kind of steel and cast iron.
 - Each insert has 2 cutting edges.
- H-NC9076:**
 - High positive geometry and sharp edge.
 - For non-ferrous material such as aluminum, titanium, brass, copper and long cutting chip metal.
 - Produces excellent surface finish on non-ferrous metal.
 - Each insert has 2 cutting edges.

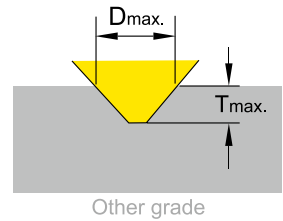
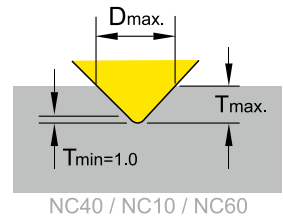

Code	Parts No.	Grade	Coating	Re	Dimensions			Dmax.	Tmax.
					L	S	Re		
014401	N9MT11T3CT-NC40	P35	TiN		11.11	3.97	0.8	14	7
014402	N9MT11T3CT-NC10	K10F	TiAlN		11.11	3.97	(0.3)		
014403	N9MT11T3CT-NC60	CERMET			11.11	3.97	0.8		
014202	N9MT11T3CT2T-H-NC40	K20F	TiN		11.11	3.97	0.8		
014203	N9MT11T3CT2T-H-NC9076	K20F	DLC		11.11	3.97	0.8		

► Holder >>

- Single cutting edge design gives higher precision when spotting.
- Applications :
 - Spotting, engraving, grooving and chamfering on milling machines, machining centers.
 - Spotting, facing on CNC Lathes.

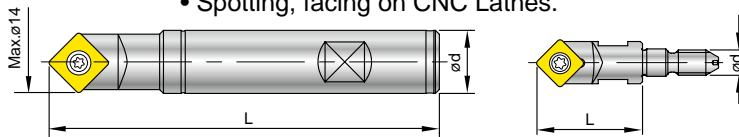

Code	Parts No.	Ød	L	Screw	Key
604002	00-99616-14-12	12	100	NS-35080 2.5 Nm	NK-T15
604004	00-99616-14	16	100		
604007	00-99616-14-150L	16	150		
604009	00-99616-14-220L	20	220		
614001	00-99616-14-1/2	1/2"	100		
614002	00-99616-14-5/8	5/8"	100		
624001	00-99616-14-M8	M8	30		

Note: • Nine9 extension bar for M8 screw fit holder, see page 68.

N9MT11T3

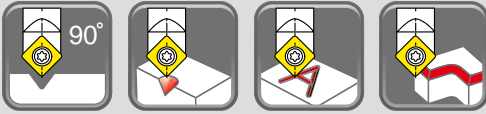

► Single Set >>

• User friendly, each set is fitted with one complimentary insert.

Code	Parts No.	Ød	Total Length	Insert fitted	Dmax.	Tmax.
604102-4401	00-99616-14-12-02S	12	100	N9MT11T3CT-NC40	14	7
604102-4402	00-99616-14-12-02SAL			N9MT11T3CT-NC10	14	7
604104-4401	00-99616-14-02S	16		N9MT11T3CT-NC40	14	7
604104-4402	00-99616-14-02SAL			N9MT11T3CT-NC10	14	7
614102-4401	00-99616-14-5/8-02S	5/8"		N9MT11T3CT-NC40	0.551"	0.276"
614102-4402	00-99616-14-5/8-02SAL			N9MT11T3CT-NC10	0.551"	0.276"

► Starter Package >>

- Selected package for starter who wants to try NC Spot Drill.
- Included one insert on tool holder and five inserts in the pocket.
- Total 6 inserts are equal to 24 spot drills.

Code	Parts No.	Ød	Insert included	Content
604202-4401	00-99616-14-12-ME6	12	N9MT11T3CT-NC40	1 tool holder + 6 inserts + 1 key
604202-4402	00-99616-14-12-ME6AL		N9MT11T3CT-NC10	
604204-4401	00-99616-14-ME6	16	N9MT11T3CT-NC40	
604204-4402	00-99616-14-ME6AL		N9MT11T3CT-NC10	
614202-4401	00-99616-14-IN6	5/8"	N9MT11T3CT-NC40	
614202-4402	00-99616-14-IN6AL		N9MT11T3CT-NC10	



► Comparison >>

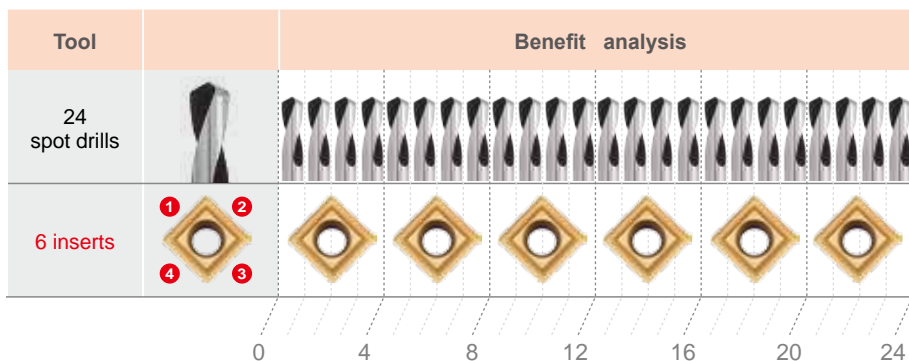

Low Cost! Economy!

6 inserts
 12 inserts
 24 inserts
 ...

=

24 spot drills
 48 spot drills
 96 spot drills
 ...

N9MT1704

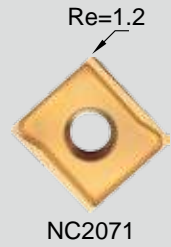
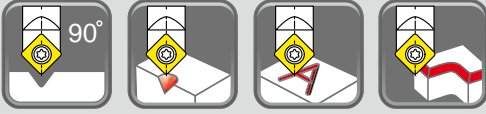

▶ Inserts >>

- 90 degree indexable spot drill insert, Dmax 22mm.

- NC2071** :
- High positive geometry, fully ground cutting edge and relief angle.
 - Universal grade for all unhardened steel and cast iron.
 - Each insert has 2 cutting edges.

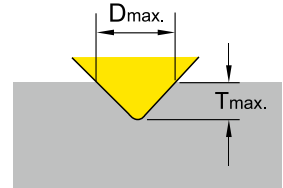

Code	Parts No.	Grade	Coating	Diagram	Dimensions			Dmax.	Tmax.
					L	S	Re		
016201	N9MT1704CT-NC2071	K20F	TiN		17	4.76	1.2	22	10.4

▶ Holder >>

- Single cutting edge design gives high precision when spotting.
- Applications :
 - Spotting, engraving, grooving and chamfering on milling machines, machining centers.
 - Spotting, facing on CNC Lathes.

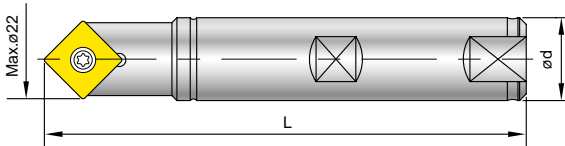

Code	Parts No.	Ød	L	Screw	Key
606001	00-99616-22	20	100	NS-50125 5.5 Nm	NK-T20
606002	00-99616-22-25	25	150		

N9MT220408



NC40

▶ Inserts >>

- For spotting diameter up to 25mm.
- Fully ground cutting edge and relief angle.

- NC40:**
- Universal grade for carbon steel, alloy steel and cast iron.
 - Each insert has 3 cutting edges.

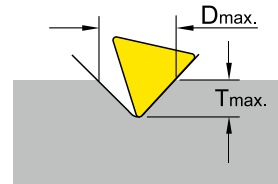

Code	Parts No.	Grade	Coating	Diagram	Dimensions			Dmax.	Tmax.
					L	S	Re		
017301	N9MT220408CT-NC40	P35	TiN		20.83	4.76	---	25	12.2

▶ Holder >>

- Large spotting diameter with indexable insert.
- Single cutting edge design gives high precision when spotting.
- Applications : spotting and chamfering on milling machine, machining centers.

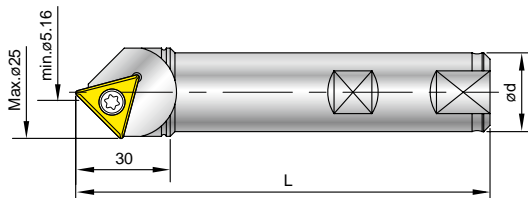

Code	Parts No.	Ød	L	Screw	Key
607001	00-99616-25-CT28	25	120	NS-40100 3.5 Nm	NK-T15
617001	00-99616-1-CT28	1"	120		

NC Spot Drill

100°
120°
142°

N9MT11T3CT2T-H

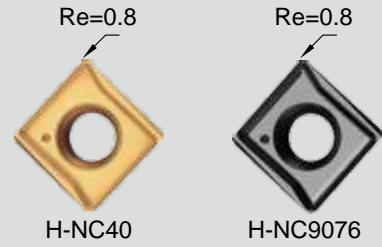

▶ Inserts >>

- H-NC40:**
- Universal grade for all kind of steel and cast iron.
 - Each insert has 2 cutting edges.
- H-NC9076:**
- High positive geometry and sharp edge.
 - For non-ferrous material such as aluminum, titanium, brass, copper and long cutting chip metal.
 - Produces excellent surface finish when chamfering non-ferrous metal.
 - Each insert has 2 cutting edges.

Code	Parts No.	Grade	Coating		Dimensions		
					L	S	Re
014202	N9MT11T3CT2T-H-NC40	K20F	TiN		11	3.97	0.8
014203	N9MT11T3CT2T-H-NC9076		DLC		11	3.97	0.8

▶ Holder >>

- Indexable insert spotting drill holders for 100°/120°/142° spotting.
- Spotting produces better hole position and geometrically uniform holes.
- Increase tool life of the next drilling operation.

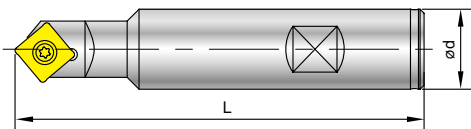

Code	Parts No.	Angle	Ød	L	Screw / Key	Dmax.	Tmax.	
604011	00-99616-20-100	100°	20	100		16	6.3	
604013	00-99616-20-120	120°	20	100	NS-35080 2.5 Nm	17	4.76	
614003	00-99616-3/4-120	120°	3/4"	100	NK-T15	0.669"	0.187"	
604014	00-99616-20-142	142°	20	100		18.5	3.16	
614004	00-99616-3/4-142	142°	3/4"	100		0.728"	0.124"	

N9MT11T3CT2T-H

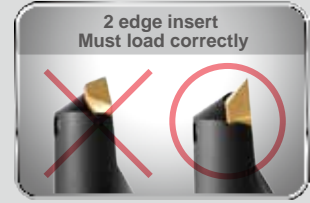

100 degree	120 degree	142 degree
<ul style="list-style-type: none"> • For aircraft 100° normal rivet hole and screw hole. 	<ul style="list-style-type: none"> • For spotting before drilling by 118° point angle drill. • 60° chamfering. 	<ul style="list-style-type: none"> • For spotting before drilling by 135°~140° point angle high performance drill.

NC Spot Drill

► Starter Package >>

- Selected package for starter who wants to try NC Spot Drill.
- Included one holder and 6 inserts.

Code	Parts No.	Angle	Ød	Insert included	Content
604211-4202	00-99616-20-100-H-ME6	100°	20	N9MT11T3CT2T-H-NC40	1 tool holder + 6 inserts + 1 key
604213-4202	00-99616-20-120-H-ME6	120°	20		
614203-4202	00-99616-3/4-120-H-IN6	120°	3/4"		
604214-4202	00-99616-20-142-H-ME6	142°	20		
614204-4202	00-99616-3/4-142-H-IN6	142°	3/4"		



V14208 / V14216

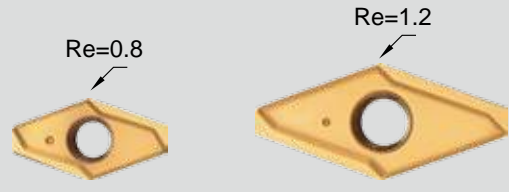
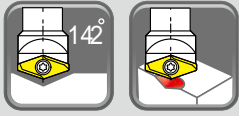

V1420803-NC2071

V1421604-NC2071

▶ Inserts >>

- For spotting before drilling by 135° - 140° point angle high performance drill.
- 142 degree indexable spotting drills. Dmax 32mm.

- NC2071:**
- High positive geometry, fully ground cutting edge and relief angle.
 - Universal grade for all unhardened steel and cast iron.
 - Each insert has 2 cutting edges.

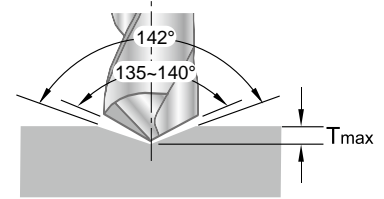

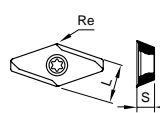

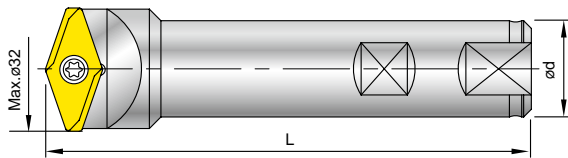

Code	Parts No.	Grade	Coating	Dimensions	Dmax.	Tmax.			
							L	S	Re
0114201	V1420803-NC2071	K20F	TiN		8	2.38	0.8	16	2.8
0114211	V1421604-NC2071		TiN		14	4.76	1.2	32	5.5

▶ Holder >>

- Using spotting first may increase higher speed and feed rate of the after drills.
- Extend your drill life with 142° spotting. Reduce your drilling cost.
- Higher accuracy of positioning and diameter tolerance !



Code	Parts No.	Insert Type	Ød	L	Screw	Key
696001	00-99619-V142-16	V1420803	16	100	 NS-30072 2.0 Nm	 NK-T9
696002	00-99619-V142-32	V1421604	25	120	 NS-50125 5.5 Nm	 NK-T20

N9MT11T3PR Radius Center Drilling

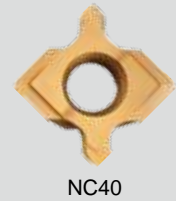

▶ Inserts >>

- Create 60° center holes SIMILAR to DIN 332 Form R, radius 2.0 / 2.5 / 3.5mm
- Carbide insert can stand very long tool life.
- Easy tool length setting, saving tool changing time.

- NC40:**
- Universal grade for all unhardened steel and cast iron.
 - Radius curve eliminates the sharp transition from drill point to countersink angle.
 - The risk of breakage is reduced.
 - Each insert has 2 cutting edges.

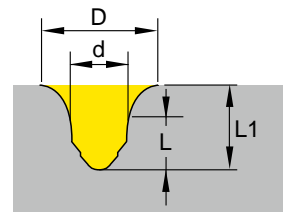

Code	Parts No.	Grade	Coating	Dimensions			
				d	D	L	L1
014205	N9MT11T3PR20-NC40	P35	TiN	2.0	5.4	2.7	3.3
014206	N9MT11T3PR25-NC40			2.5	5.9	3.0	3.7
014207	N9MT11T3PR30-NC40			3.0	6.4	3.3	4.0

▶ Holder >>

- PR holder has small offset value.
- Also apply as a 90° spotting drill while fitted with N9MT11T3CT2T-H insert (page 21).

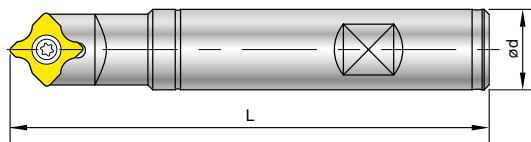

Code	Parts No.	ød	L	Screw	Key
604004PR	00-99616-14-PR	16	100	NS-35080 2.5 Nm	NK-T15

▶ Turning and Centering Capacity on CNC Lathes

Action	
1	Center Drilling
2	Facing
3	Chamfering
4	External Turning

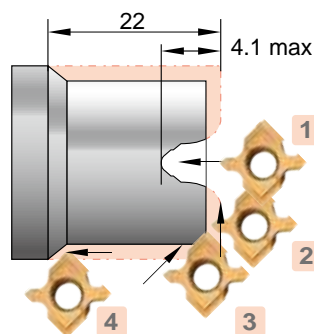



Corner Rounding >>

Various corner radius inserts can fit on same holder

Carbide insert can stand very long tool life

Produces smooth and excellent surface finish on workpiece.

Features

► Type of RC

- Each insert has 2 cutting edges.
- Combination corner rounding and 45° chamfering application on same insert.
- Higher cutting speed and feed rate.
- Very small X offset, good for contour chamfering.
- Utilizes standard NC Spot Drill holders 99616-06, 99616-14 & 99616-22.

► Type of R

- Each insert has 4 cutting edges.
- R1.0 ~ R3.0 inserts are interchangeable on same holder.
- For front and back chamfering.
- Tool offset can be set after measuring tool length by tool presetter or Z-Zero Setter.



◀ Applications

- a** Radius 0.5
- b** Radius 1.0
- c** Radius 2.0



RC

Corner Rounding

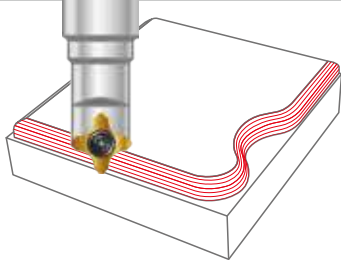

RC

Circular Corner Rounding

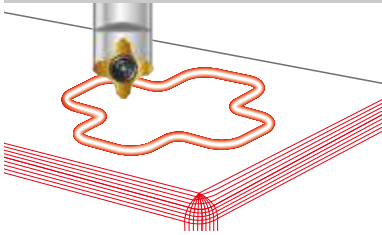

R

**Front & Back
Corner Rounding**

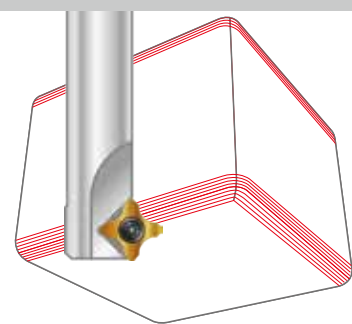

R

**Back
Circular Corner Rounding**

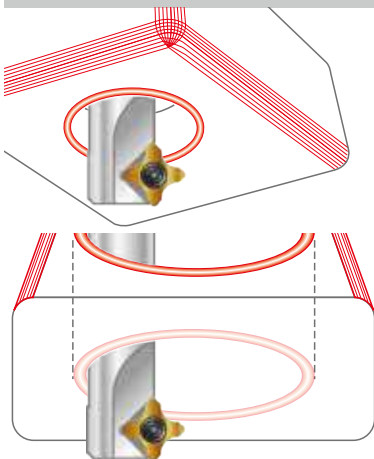

- ▶ Inserts are CNC ground for precision radius and location.
- ▶ Optimizes the tool performance and reduces the cutting time.

N9MT05T1RC



RC0.5~RC1.0
All are interchangeable
on same holder



NC2071

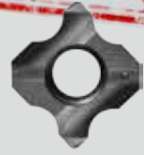

NC9036

► Inserts >>

- Various corner radius inserts can fit on same holder.
- Very small X offset 1.25mm for radius 0.5,
good for small components needs a small corner rounding for removing burrs.

- NC2071:**
- Universal grade for all unhardened steel and cast iron.
 - Inserts are CNC ground for precision radius location.
 - Each insert has 2 cutting edges.

- NC9036:**
- For non-ferrous material such as aluminum, acrylic, titanium, brass, copper and stainless steel.
 - High positive geometry and sharp edge produces excellent surface finish.
 - Each insert has 2 cutting edges.

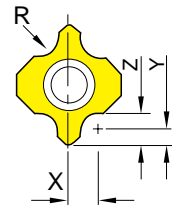

Insert Radius	Code	Parts No.	Grade	Coating	offset			Dimensions		
					X ±0.03	Y ±0.03	Z			
0.5	011203	N9MT05T1RC05-NC2071	K20F	TiN	1.25	0.75	1.25		L	S
	011206	N9MT05T1RC05-NC9036		DLC						
0.75	011204	N9MT05T1RC075-NC2071		TiN	1.50	0.75	1.50			
	011207	N9MT05T1RC075-NC9036		DLC						
1.0	011205	N9MT05T1RC10-NC2071		TiN	1.75	0.75	1.75			
	011208	N9MT05T1RC10-NC9036		DLC						

► Holder >>

- For corner rounding using **NC Spot Drill** shank.

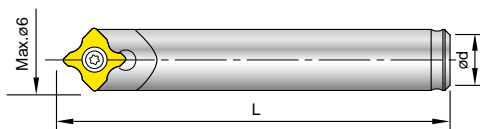

Code	Parts No.	Ød	L	Screw	Key
601001	00-99616-06-6	6	35	NS-20036 0.8 Nm	NK-T6
601002	00-99616-06-5	5	35		
601003	00-99616-06-6L	6	60		

* 601003 is carbide shank holder

N9MT11T3RC



RC1.0~RC3.0
All are interchangeable on same holder



NC40

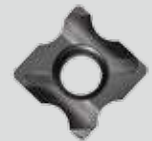

NC9036

▶ Inserts >>

- Higher cutting speed and feed rate.
- Combination corner rounding and 45° chamfering application on same insert.
- Various corner radius inserts can fit on same holder.

- NC40:**
- Universal grade for all unhardened steel and cast iron.
 - Inserts are CNC ground for precision radius location.
 - Each insert has 2 cutting edges.

- NC9036:**
- For non-ferrous material such as aluminum, acrylic, titanium, brass, copper and stainless steel.
 - High positive geometry and sharp edge produces excellent surface finish.
 - Each insert has 2 cutting edges.

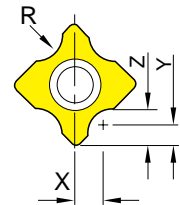

Insert Radius	Code	Parts No.	Grade	Coating	offset			Dimensions	
					X ±0.03	Y ±0.03	Z	L	S
1.0	014209	N9MT11T3RC10-NC40	K20F	TiN	2.75	1.5	2.5	11.11	3.97
	014224	N9MT11T3RC10-NC9036		DLC					
1.5	014210	N9MT11T3RC15-NC40		TiN	3.25	1.5	3		
	014225	N9MT11T3RC15-NC9036		DLC					
2.0	014211	N9MT11T3RC20-NC40		TiN	3.75	1.5	3.5		
	014226	N9MT11T3RC20-NC9036		DLC					
2.5	014212	N9MT11T3RC25-NC40		TiN	4.25	1.5	4		
	014227	N9MT11T3RC25-NC9036		DLC					
3.0	014213	N9MT11T3RC30-NC40		TiN	4.75	1.4	4.4		
	014228	N9MT11T3RC30-NC9036		DLC					
1/64	014214	N9MT11T3RC1/64-NC40		TiN	0.086"	0.059"	0.0747"	0.437"	0.156"
	014229	N9MT11T3RC1/64-NC9036		DLC					
1/32	014215	N9MT11T3RC1/32-NC40		TiN	0.101"	0.059"	0.090"		
	014230	N9MT11T3RC1/32-NC9036		DLC					
1/16	014216	N9MT11T3RC1/16-NC40		TiN	0.133"	0.059"	0.122"		
	014231	N9MT11T3RC1/16-NC9036		DLC					
3/32	014217	N9MT11T3RC3/32-NC40		TiN	0.164"	0.059"	0.153"		
	014232	N9MT11T3RC3/32-NC9036		DLC					
1/8	014218	N9MT11T3RC 1/8-NC40		TiN	0.199"	0.055"	0.180"		
	014233	N9MT11T3RC 1/8-NC9036		DLC					

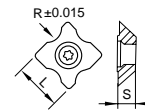

▶ Holder >>

- For corner rounding using **NC Spot Drill** shank.

Code	Parts No.	Ød	L	Screw/ Key
604002	00-99616-14-12	12	100	NS-35080 2.5 Nm
604004	00-99616-14	16		
614001	00-99616-14-1/2	1/2"	100	NK-T15
614002	00-99616-14-5/8	5/8"		

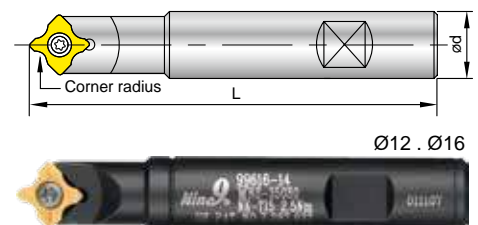

Corner Rounding

N9MT1704RC



RC4.0~RC6.0
All are interchangeable
on same holder



NC2071



NC9036

▶ Inserts >>

- Higher cutting speed and feed rate.
- Combination corner rounding and 45° chamfering application on same insert.
- Various corner radius inserts can fit on same holder.

NC2071:

- Universal grade for all unhardened steel and cast iron.
- Inserts are CNC ground for precision radius location.
- Each insert has 2 cutting edges.

New NC9036:

- For non-ferrous material such as aluminum, acrylic, titanium, brass, copper and stainless steel.
- High positive geometry and sharp edge produces excellent surface finish.
- Each insert has 2 cutting edges.

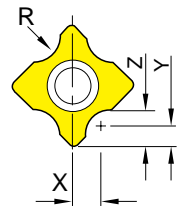

Corner radius(R)	Code	Parts No.	Grade	Coating	offset			Dimensions	
					X ±0.03	Y ±0.03	Z	L	S
4.0	016202	N9MT1704RC40-NC2071	K20F	TiN	6.15	2	6	17	4.76
4.0	016208	N9MT1704RC40-NC9036		DLC	6.15	2	6		
5.0	016203	N9MT1704RC50-NC2071		TiN	7.1	2	7		
5.0	016209	N9MT1704RC50-NC9036		DLC	7.1	2	7		
6.0	016204	N9MT1704RC60-NC2071		TiN	8.1	2	8		
6.0	016210	N9MT1704RC60-NC9036		DLC	8.1	2	8		

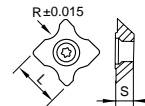

▶ Holder >>

- For corner rounding using **NC Spot Drill** shank.
- Good for small work pieces, which need large corner rounding.

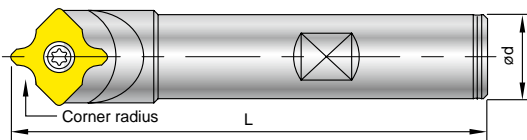

Code	Parts No.	Ød	L	Screw	Key
606001	00-99616-22	20	100	NS-50125 5.5 Nm	NK-T20
606002	00-99616-22-25	25	150		

N9MT11T3R



R1.0~R3.0
All are interchangeable
on same holder



▶ Inserts >>

- For front and back corner rounding.
- Various corner radius inserts can fit on same holder.
- Carbide insert can stand very long tool life.
- Each insert has 4 cutting edges.

NC2071: • Universal grade for all unhardened steel and cast iron.
• Inserts are CNC ground for precision radius location.

Corner radius(R)	Code	Parts No.	Grade	Coating		Dimensions	
						L	S
1.0	014404	N9MT11T3R10-NC2071	P35	TiN		11.11	3.97
1.5	014405	N9MT11T3R15-NC2071	P35	TiN			
2.0	014406	N9MT11T3R20-NC2071	P35	TiN			
2.5	014407	N9MT11T3R25-NC2071	P35	TiN			
3.0	014408	N9MT11T3R30-NC2071	P35	TiN			

▶ Holder >>

- Center of radius of each tool is dedicated.
- Tool offset can be set after measuring tool length by tool presetter or Z-Zero Setter.

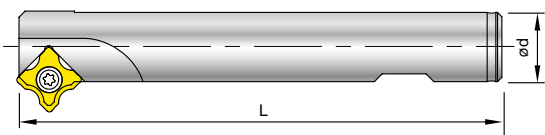

Code	Parts No.	Ød	L	Z	Screw	Key
604015	00-99616-16-25R	16	100	1	NS-35080 2.5 Nm	NK-T15
604019	00-99616-16-30R	16	120	1		
604020	00-99616-25-40R	25	150	4		

▶ More >>

- Also can fit with N9MT11T308LA inserts for front and back chamfering. (Please see page 36)

N9MT11T3R



▶ Cutting Position >>

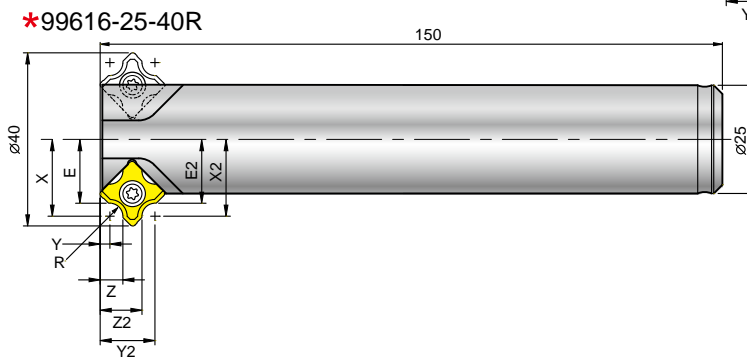
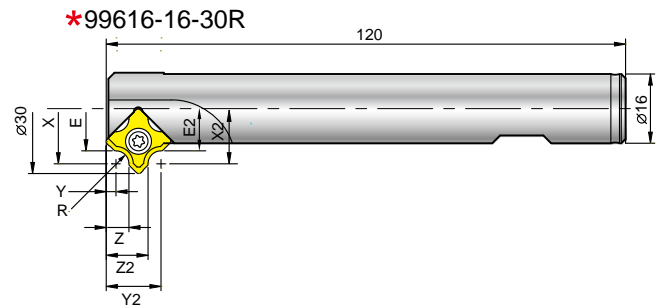
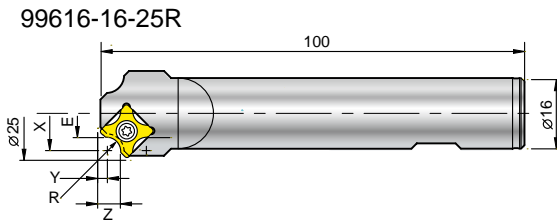

99616-16-30R & 99616-25-40R
 *For front and back corner rounding.
 *Eliminates 2nd operation or de-burring time.

Insert Radius	Holder	Front Chamfering				Back Chamfering				⊕ Z
		E	X	Y	Z	E2	X2	Y2	Z2	
R1.0	00-99616-16-25R	8.25	9.25	3.25	4.25	---	---	---	---	1
	00-99616-16-30R	10.75	11.75	3.25	4.25	10.75	11.75	11.65	10.65	1
	00-99616-25-40R	15.75	16.75	3.25	4.25	15.75	16.75	11.65	10.65	4
R1.5	00-99616-16-25R	8	9.5	3	4.5	---	---	---	---	1
	00-99616-16-30R	10.5	12	3	4.5	10.5	12	11.9	10.4	1
	00-99616-25-40R	15.5	17	3	4.5	15.5	17	11.9	10.4	4
R2.0	00-99616-16-25R	7.75	9.75	2.75	4.75	---	---	---	---	1
	00-99616-16-30R	10.25	12.25	2.75	4.75	10.25	12.25	12.15	10.15	1
	00-99616-25-40R	15.25	17.25	2.75	4.75	15.25	17.25	12.15	10.15	4
R2.5	00-99616-16-25R	7.5	10	2.5	5	---	---	---	---	1
	00-99616-16-30R	10	12.5	2.5	5	10	12.5	12.4	9.9	1
	00-99616-25-40R	15	17.5	2.5	5	15	17.5	12.4	9.9	4
R3.0	00-99616-16-25R	7.25	10.25	2.25	5.25	---	---	---	---	1
	00-99616-16-30R	9.75	12.75	2.25	5.25	9.75	12.75	12.65	9.65	1
	00-99616-25-40R	14.75	17.75	2.25	5.25	14.75	17.75	12.65	9.65	4

N9MT11T308LA 45° Chamfering Tool

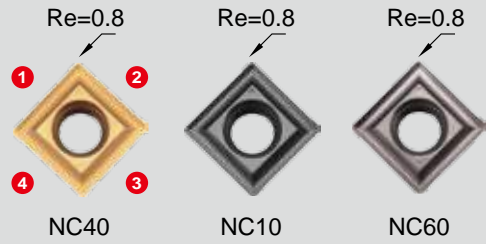

▶ Inserts >>

- NC40:**
 - General purpose, universal grade for all unhardened steel.
 - Each insert has 4 cutting edges.
- NC10:**
 - High positive angle and fully ground cutting edge and relief angle.
 - Universal grade for Al, Al-alloy, non-ferrous metal, cast iron and stainless steel.
 - Each insert has 4 cutting edges.
- NC60:**
 - Cermet insert, for hardened steel up to HRC56 .
 - Each insert has 4 cutting edges.

Code	Parts No.	Grade	Coating		Dimensions		
					L	S	Re
014409	N9MT11T308LA -NC40	P35	TiN		11.11	3.97	0.8
014410	N9MT11T308LA -NC10	K10F	TiAN				
014411	N9MT11T308LA -NC60	Cermet					

▶ Holder >>

- 99616-28 can be applied for machining back chamfering and side grooving.

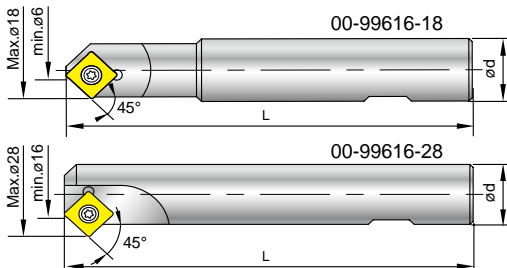

Code	Parts No.	Insert type	Chamfering	Ød	L	Z	Screw / Key
604017	00-99616-18	N9MT11T308LA	Ø6-Ø18	20	120	1	NS-35080 2.5 Nm
604018	00-99616-28		Ø16-Ø28	20	120	1	NK-T15

▶ Example >>

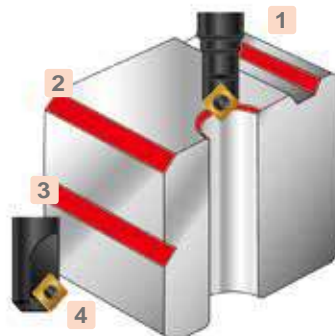
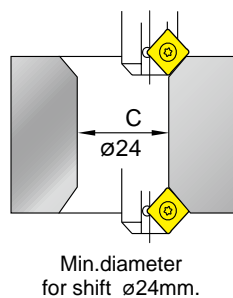
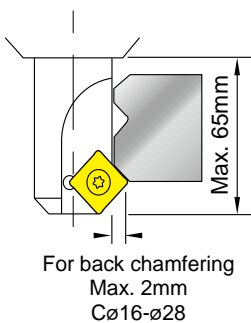

Action	
1	External and internal chamfering
2	Side chamfering
3	Side grooving
4	Back chamfering

Cutting Data

► Diameter / Depth Chart and Speed / Feed Rate Calculation of NC Spot Drill

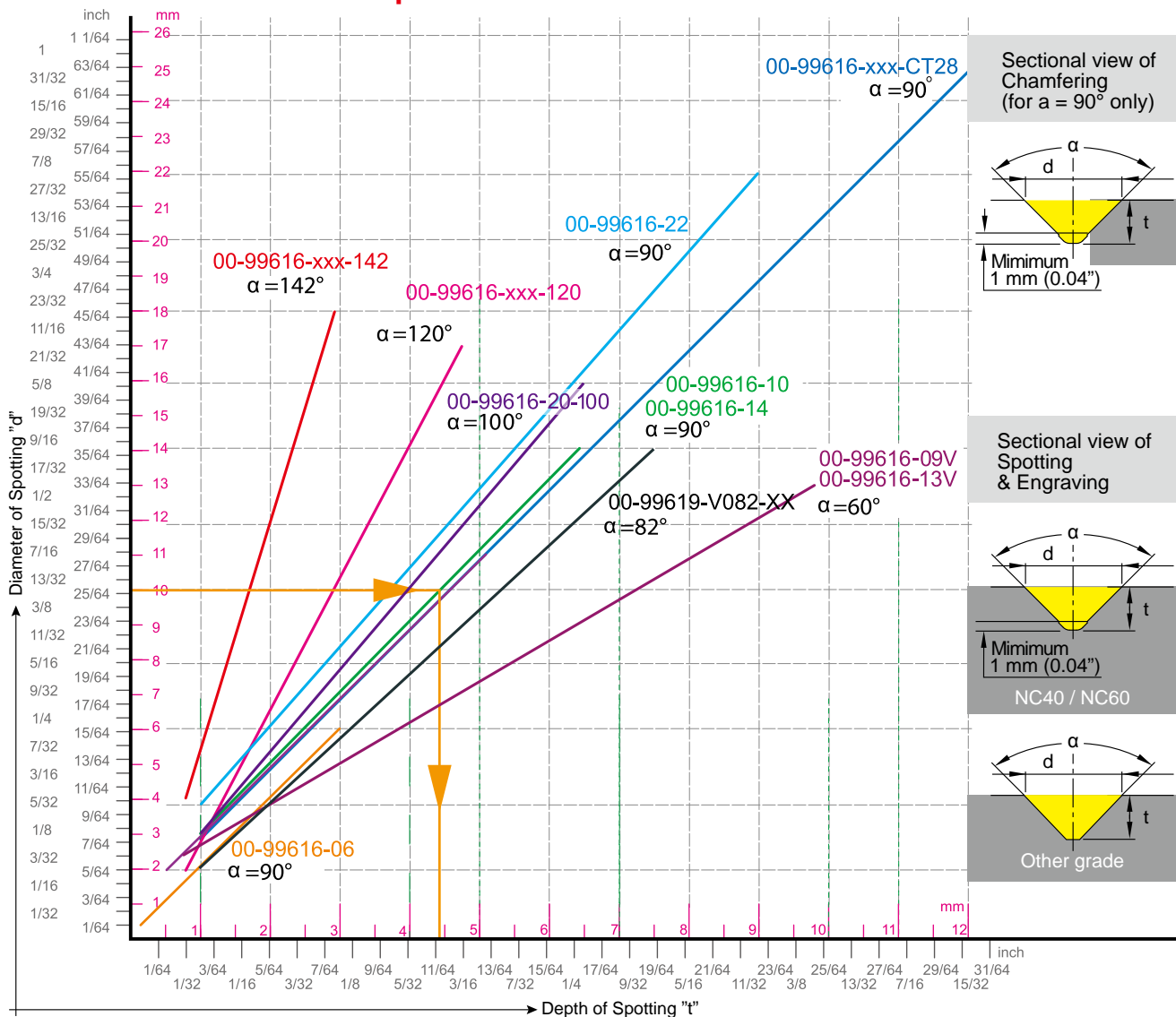

► Instruction of Use >>

1. From Spot diameter "d" to get drill depth "t".
2. Point angle "α" is determined by which tool holder you use.
3. From "d" draw a horizontal line to get intersection of the line by point angle "α".
4. From the intersection draw a vertical line to the bottom to have depth of spotting "t". "t" is the drill depth of the NC program.
5. The sectional view of spotting will depend on the shape of insert, NC40 and other grade of inserts have different sectional view.
6. For chamfering, do not use tip of insert, 1mm(0.04") minimum clearance is required for a smooth surface finish.

► Calculate spindle speed and feed rate >>

1. Using your "d" value and cutting speed Vc from the data sheet, calculate spindle speed "S"(RPM).
2. "F" feed rate per minute $F = f \times S = \text{RPM} \times \text{IPR}$

Metric		Inch	
	d = diameter -mm		d = diameter-inch
$S = \frac{Vc \times 1000}{\pi \times d}$	S = Spindle Speed -r.p.m.	$S = \frac{(3.82 \times SFM)}{d}$	S = Spindle Speed-r.p.m.
	Vc = Cutting Speed -m/min.		SFM = Surface Speed-ft./min. Vc (m/min.) x 3.28
$F = S \times f$	f = mm/rev.	$F = f \times S$	f = IPR = inch/rev.
	F = mm/min.		F = inch/min.

Cutting Data

► N9MT-CT >> Insert Multi-function

Determine spindle speed and feed rate:

- Choose spotting depth to decide spotting diameter according to the Diameter/Depth chart of page 37.
- The spindle speed should be calculated by the maximum diameter of spotting, chamfering and grooving.

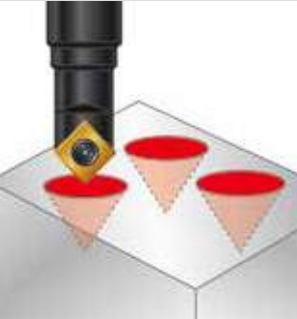
Spotting	Work Material	Vc (m/min)	f (mm/rev.)	Grade of Insert
	Carbon Steel	150~250	0.05~0.10	NC40, NC2071
	Alloy Steel	100~200	0.04~0.08	NC40, NC2071
	Stainless Steel	65~125	0.03~0.06	NC10, NC60, NC40, NC2071
	Cast iron	80~150	0.05~0.10	NC40, NC10, NC2071
	Non-Ferrous Metal (Al, Cu)	150~300	0.05~0.10	NC10, NC9076, NC2071
	Ti, Ti-alloy	60~80	0.03~0.06	NC9076
	Hardened steel HRC 40°~56°	30~60	0.03~0.08	NC60

- * For technical construction reasons, the insert is not located on the center of the holder.
- * Inserts with supporting edges can increase feed rate 50%.

Chamfering	Work Material	Vc (m/min)	f (mm/rev.)	Grade of Insert
	Carbon Steel	150~320	0.15~0.24	NC40, NC2071
	Alloy Steel	100~250	0.12~0.20	NC40, NC2071
	Stainless Steel	65~125	0.1~0.20	NC10, NC60, NC40, NC2071
	Cast iron	150~250	0.15~0.25	NC40, NC10, NC2071
	Non-Ferrous Metal (Al, Cu)	150~320	0.15~0.25	NC10, NC9076, NC2071
	Ti, Ti-alloy	60~80	0.03~0.06	NC9076
	Hardened steel HRC 40°~56°	30~60	0.03~0.08	NC60

Grooving	Work Material	Vc (m/min)	f (mm/rev.)	Grade of Insert
	Carbon Steel	150~250	0.05~0.10	NC40, NC2071
	Alloy Steel	100~200	0.04~0.08	NC40, NC2071
	Stainless Steel	65~125	0.03~0.06	NC10, NC60, NC40, NC2071
	Cast iron	80~150	0.05~0.08	NC40, NC10, NC2071
	Non-Ferrous Metal (Al, Cu)	150~320	0.05~0.08	NC10, NC9076, NC2071
	Ti, Ti-alloy	60~80	0.03~0.06	NC9076
	Hardened steel HRC 40°~56°	30~60	0.03~0.08	NC60

► N9MT-W Insert / Engraving Insert

Engraving : Width of engraving=diameter of cutting="d"
Depth of engraving=depth of cutting="T"

- Tool shank runout should be below 0.01mm

Engraving

- For $\alpha = 90^\circ$ insert, $d=2xT$
- For $\alpha = 60^\circ$ insert, $d=1.73xT$

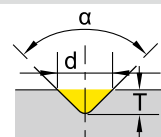



Mini spotting	Work Material	Vc (m/min)	f (mm/rev.)	Grade of Insert	Depth of cut			
					1st	2nd	3th	Finishing
	All Kind of Steel, unhardened, Cast iron	20~80	0.008~0.02	NC40	0.3	0.2	0.2	0.1
	Non-Ferrous Metal (Al, Cu)	20~100	0.008~0.02	NC10	0.3	0.2	0.2	0.1

Attention: The calculated result "d" is only for calculation of spindle speed.

Cutting Data

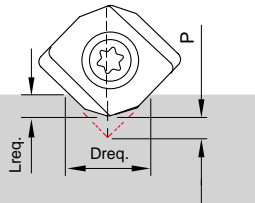
► W Spotting >>

W spotting	Formula											
	P = distance of theoretical intersection point to tip of insert.											
	0.5 = fixed factor for calculation											
	Lreq. = required drilling depth											
	Dreq. = required diameter											
	M4	M5	M6	M8	M10	M12	M14	M16	1/4-20 UNC	5/16-18 UNC	3/8-16 UNC	
P =	1.17	1.48	1.76	2.39	2.97	3.59	4.19	4.88	1.80	2.30	2.78	

W spotting	Work Material	Vc (m/min)	f (mm/rev.)
	Carbon Steel	150 ~ 300	0.05 ~ 0.15
	Alloy Steel	120 ~ 250	0.05 ~ 0.10
	Stainless Steel	80 ~ 150	0.04 ~ 0.08
	Cast iron	100 ~ 200	0.05 ~ 0.10

► LA Insert >> 45° Chamfering

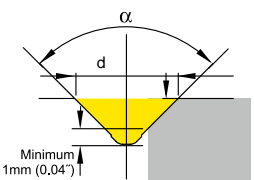
45° Chamfering	Formula		
	α = point angle 90°		
	d = effective diameter		
	Vc = cutting speed m/min.or ft./min.		
	S = Spindle speed		
	f = feed per rev. mm/rev.		
	S = $\frac{Vc \times 1000}{d \times \pi}$ r.p.m.		
	F = S x f mm/min.		

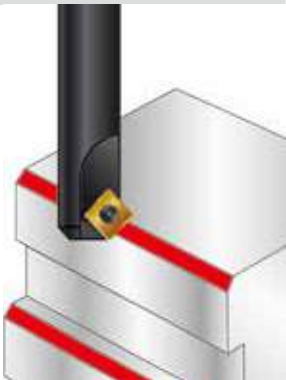
45° Chamfering	Work Material	Vc (m/min)	f (mm/rev.)	Grade of Insert
	Carbon Steel	150-320	0.05-0.10	NC40
	Alloy Steel	100-250	0.04-0.08	NC40
	High alloy steel	60-80	0.03-0.06	NC40
	Stainless Steel	65-125	0.03-0.06	NC10
	Cast iron	150-250	0.05-0.10	NC10, NC40
	Aluminum, Al-alloy Si < 12%	150-320	0.05-0.10	NC10
	Al-alloy Si > 12%	100-300	0.05-0.10	NC10
	Cu	200-250	0.05-0.10	NC10
	Brass and Bronze	150-250	0.05-0.10	NC10
	Hardened steel HRC 40~56°	60-80	0.05-0.10	NC60

► PR Insert >> Radius Center Drilling

Center Drilling	Work Material	Vc (m/min)	f (mm/rev.)	Grade of Insert
	Carbon Steel	80-150	0.05-0.20	NC40
	Alloy steel	80-150	0.05-0.20	
	High alloy steel	80-150	0.05-0.20	
	Cast iron	80-150	0.05-0.20	

Cutting Data

► N9MT-RC Insert >> Corner Rounding

Determine spindle speed and feed:

To decide running speed of the tools and feed rate, please calculate spindle speed and feed rate according to the following formula and cutting data:

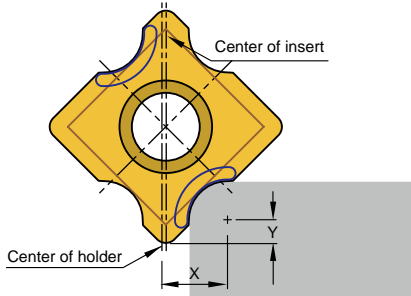

Corner Rounding

Calculate spindle speed

$$d = 2 \times X \quad \text{mm}$$

$$S = \frac{V_c \times 1000}{d \times \pi} \quad \text{r.p.m.}$$

$$F = S \times f \quad \text{mm/min.}$$

d = diameter of the tool for calculation purpose

X = tool radius offset (ref. page 31~33 for RC inserts)

V_c = Cutting Speed -m/min.

S = Spindle Speed -r.p.m.

F = mm/min.

f = mm/rev.

Calculate tool length offset on machining center

$$TL = TL' - Y,$$

$$H = X$$

X = tool radius offset (ref. page 31~33 for RC inserts)

Y = distance to the center of radius.
(ref. page 31~33 for RC inserts)

TL' = tool length

TL = tool length offset.

H = tool radius offset

RC Insert	Work Material	Vc (m/min)	f (mm/rev.)	Grade of Insert
	Carbon Steel	150~320	0.05~0.10	NC40, NC2071
	Alloy steel	100~250	0.05~0.10	NC40, NC2071
	High alloy steel	80~150	0.04~0.08	NC40, NC2071
	Stainless Steel	65~125	0.05~0.10	NC9036
	Cast iron	150~250	0.05~0.10	NC40, NC2071
	Aluminum, Al-alloy Si < 12%	150~320	0.05~0.10	NC9036
	Al-alloy Si > 12%	100~300	0.05~0.10	NC9036
	Cu	200~250	0.05~0.10	NC9036
	Brass and Bronze	150~250	0.05~0.10	NC9036

► N9MT-R Insert >> Corner Rounding (4 cutting edges)

R Insert	Work Material	Vc (m/min)	f (mm/rev.)	Grade of Insert
	Carbon Steel	150~320	0.05~0.10	NC2071
	Alloy steel	100~250	0.04~0.08	NC2071
	High alloy steel	60~80	0.03~0.06	NC2071
	Cast iron	150~250	0.05~0.10	NC2071



Center Drill >> i-Center®

The “ i-Center ” is a trademark of Nine9, the developer of the first indexable center drill in the world. (Patented)
Offering an indexable insert system for the 1st time, Nine9’s “i-Center ” design improves your process performance.

Features

World’s first indexable center drill
Shortens set up and center drilling time
Increases tool life and reduces tooling costs

▶ High Speed, High Feed Rate

- The special ground insert and rigid holder design facilitate high performance speed and feed rates. For example, drilling alloy steel at 6000 rpm and feed rate of 600 mm/min. (0.1 mm/rev.)

▶ Easy Tool Length Setting

- The axial position accuracy of the insert is 0.05 mm (.002”). It is not necessary to reset the tool length when changing the insert or cutting edge.

▶ Excellent Repeatability

- The insert is positioned by two fixed pins and clamped by one insert screw at the center.
- The positioning repeatability of the insert is within 0.02 mm (.0008”) in radial direction, thus ensuring conformity to any national standards.



▶ High pressure coolant can be supplied through center directly to tip of center drill insert.

▶ Extended Tool Life

- Coolant can be supplied through the center of the holder to increase performance and extend tool life.
- Insert geometry, grades and coating process are specifically engineered for centering applications.

▶ Special forms are possible



* Standard stock item

* **DIN 332 Form R**

Ø1.0~Ø10

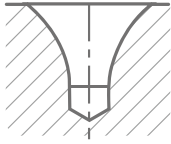

* **DIN 332 Form A + B**

Ø1.0~Ø10

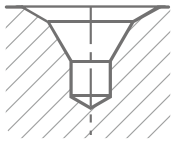

* **DIN 332 Form A**

Ø2.0~Ø3.15

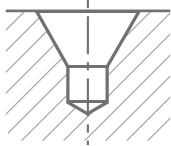

* **ANSI 60°**

#2.0~#10

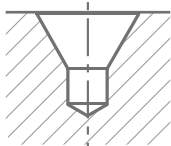

C Type

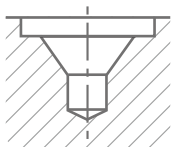

F Type

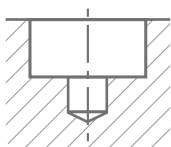

▲ Excellent repeatability by insert type.
No need tool length re-setting while changing insert or cutting edge.

Indexable Center Drill

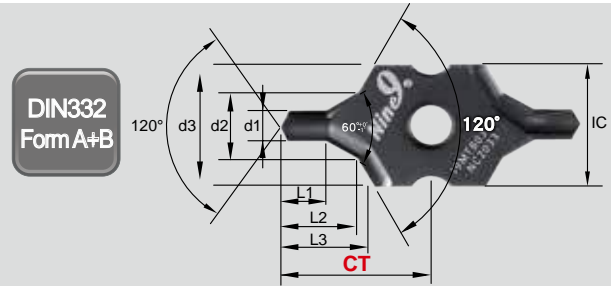
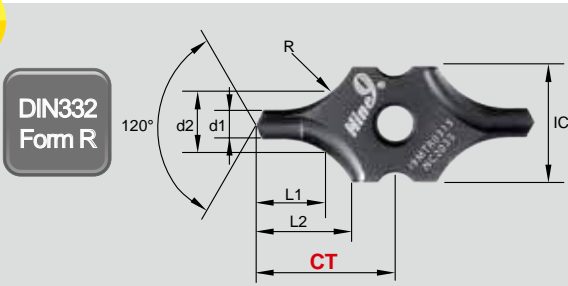

► DIN332 Form R >>

Code	Parts No.	Grade	Coating	d1	d2	L1	L2	R	CT ±0.025	IC	
032201	I9MT08T1R0100-NC2033	K20F	TiAlN	1.00	+ 0.14 0	2.12	2.16	4.14	2.8	7.55	08
032202	I9MT08T1R0125-NC2033			1.25		2.65	2.74	4.64	3.5	7.90	
032203	I9MT08T1R0160-NC2033			1.60		3.35	3.45	5.13	4.5	8.40	
032204	I9MT08T1R0200-NC2033			2.00		4.25	4.45	6.08	5.65	9.10	
033201	I9MT12T2R0200-NC2033			2.00	+ 0.14 0	4.25	4.45	6.64	5.65	11.73	12
033202	I9MT12T2R0250-NC2033			2.50	5.3	5.59	8.11	7.15	13.00		
033203	I9MT12T2R0315-NC2033			3.15	+ 0.18 0	6.7	7.21	9.63	9.0	14.00	16
034201	I9MT1603R0400-NC2033			4.00		8.5	9.06	12.23	11.0	19.40	
034202	I9MT1603R0500-NC2033			5.00	10.6	11.45	14.2	14.0	19.40	20	
035201	I9MT2004R0630-NC2033			6.30	+ 0.22 0	13.2	14.63	18.2	18.0		28.40
035202	I9MT2004R0800-NC2033			8.00		17.0	18.63	20.44	22.5	28.30	
036201	I9MT2506R1000-NC2033			10.00		21.2	23.51	25.8	28.0	34.20	25



► DIN332 Form A+B >>

Code	Parts No.	Grade	Coating	d1	d2	d3	L1	L2	L3	CT ±0.025	IC	
032001	I9MT08T1B0100-NC2033	K20F	TiAlN	1.00	+ 0.14 0	2.12	3.15	1.3	2.21	2.51	7.55	08
032002	I9MT08T1B0125-NC2033			1.25		2.65	4.0	1.6	2.75	3.14	7.90	
032003	I9MT08T1B0160-NC2033			1.60		3.35	5.0	2.0	3.46	3.93	8.4	
032004	I9MT08T1B0200-NC2033			2.00		4.25	6.3	2.5	4.39	4.98	9.1	
033001	I9MT12T2B0200-NC2033			2.00	+ 0.14 0	4.25	6.3	2.5	4.39	4.98	11.73	12
033002	I9MT12T2B0250-NC2033			2.50	5.3	8.0	3.1	5.53	6.28	13.0		
033003	I9MT12T2B0315-NC2033			3.15	+ 0.18 0	6.7	10.0	3.9	6.90	7.85	14.0	16
034001	I9MT1603B0400-NC2033			4.00		8.5	12.5	5.0	8.9	10.03	19.4	
034002	I9MT1603B0500-NC2033			5.00	10.6	16.0	6.3	11.15	12.68	19.4	20	
035001	I9MT2004B0630-NC2033			6.30	+ 0.22 0	13.2	18.0	8.0	13.98	15.33		28.4
035002	I9MT2004B0800-NC2033			8.00		17.0	20	10.1	17.89	18.73	28.3	
036001	I9MT2506B1000-NC2033			10.00		21.2	25	12.8	22.5	23.57	34.2	25

DIN332 Form A

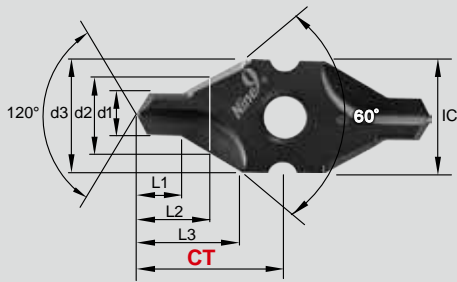

ANSI 60°

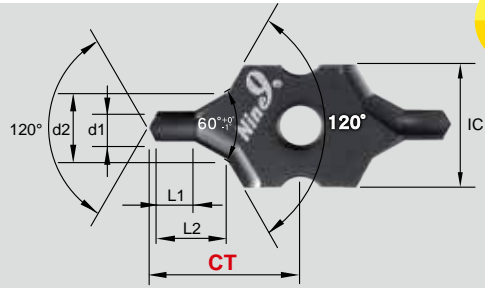

► **DIN332 Form A >>**

Code	Parts No.	Grade	Coating	d1	d2	d3	L1	L2	L3	CT ±0.025	IC	
032104	I9MT08T1A0200-NC2033	K20F	TiAlN	2.0	+0.14	4.25	8	2.15	4.10	7.35	10.5	08
032105	I9MT08T1A0250-NC2033			2.5	0	5.3		2.58	5.00	7.34		
032106	I9MT08T1A0315-NC2033			3.15	+0.18	6.7		3.23	6.30	7.43		



► **ANSI 60° >>**

Code	Parts No.	Grade	Coating	Size	d1		d2		L1		L2	CT ±0.025	IC	
						mm		mm		mm	mm			
033101	I9MT12T2A2-NC2033	K20F	TiAlN	#2	5/64	1.98	+0.14	3/16	4.76	5/64	1.98	4.4	12.6	12
033102	I9MT12T2A3-NC2033			#3	7/64	2.78	0	1/4	6.35	7/64	2.78	5.9	13.8	
033103	I9MT12T2A4-NC2033			#4	1/8	3.18	+0.18	5/16	7.94	1/8	3.18	7.3	14.25	
034101	I9MT1603A5-NC2033			#5	3/16	4.76	0	7/16	11.11	3/16	4.76	10.3	20.0	16
035101	I9MT2004A6-NC2033			#6	7/32	5.56	+0.22	1/2	12.7	7/32	5.56	11.8	27.75	20
035102	I9MT2004A7-NC2033			#7	1/4	6.35	0	5/8	15.88	1/4	6.35	14.6	28.5	
035103	I9MT2004A8-NC2033			#8	5/16	7.94	+0.22	3/4	19.05	5/16	7.94	17.6	29.0	
036101	I9MT2506A10-NC2033			#10	3/8	9.53	0	0.98"	25.0	3/8	9.53	22.9	34.9	25

► **Holder >>**

- Made of hardened high alloy steel.
- Shank is ground to h6 tolerance.
- Special holders are available on request.

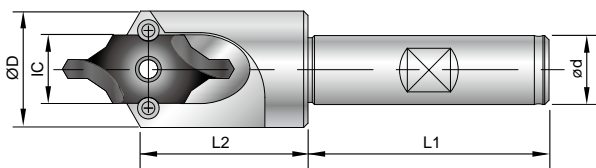

Code	Parts No.	Type	IC	ød	L1	L2	øD	Screw	Key
802001	00-99616-IC08-10	BC10-IC08	08	10	30	18.5	12	NS-25060 1.2 Nm	NK-T7
803001	00-99616-IC12-16	SB16-IC12	12	16	48	30.5	21	NS-30072 2.0 Nm	NK-T9
804001	00-99616-IC16-16	SB16-IC16	16	16	48	37	27	NS-35080 2.5 Nm	NK-T15
805001	00-99616-IC20-20	SB20-IC20	20	20	50	51	32	NS-50125 5.5 Nm	NK-T20
806001	00-99616-IC25-25	SB25-IC25	25	25	56	56	43	NS-50125 5.5 Nm	NK-T20
Code	Parts No.	Type	IC	ød	L1	L2	øD	Screw	Key
812001	00-99616-IC08-3/8	BC3/8"-IC08	08	3/8"	30	18.5	12	NS-25060 1.2 Nm	NK-T7
813001	00-99616-IC12-5/8	SB5/8"-IC12	12	5/8"	48	30.5	21	NS-30072 2.0 Nm	NK-T9
814001	00-99616-IC16-5/8	SB5/8"-IC16	16	5/8"	48	37	27	NS-35080 2.5 Nm	NK-T15
815001	00-99616-IC20-3/4	SB3/4"-IC20	20	3/4"	50	51	32	NS-50125 5.5 Nm	NK-T20
816001	00-99616-IC25-1	SB 1"-IC25	25	1"	56	56	43	NS-50125 5.5 Nm	NK-T20

Cutting Data

► Attention >>

- For $d1 < 4$ mm or size #5, the center misalignment must be less than 0.05mm.
- If the CNC lathe turret center's misalignment is above 0.15mm, please use the Center Height Adjusting Sleeve. (See page 68)
- For low spindle speed special purpose machines or lathes, lower spindle speed is allowed but the feed rate should be maintained.

► $\varnothing 1 \sim \varnothing 4$ (#2~#5) >>

Work piece material	Vc (m/min.)	f d1	f (mm/rev)					Cutting fluid
			IC08		IC12			
			$\varnothing 1 \sim 1.25$	$\varnothing 1.6 \sim 3.15$	$\varnothing 2$ (#2)	$\varnothing 2.5$ (#3)	$\varnothing 3.15$ (#4)	
Carbon steel C<0.3%	60-70-80	(S=17825 rpm) 0.02-0.03-0.05	(S=13930 rpm) 0.03-0.05-0.06	(S=11140 rpm) 0.04-0.06-0.08	(S=8912 rpm) 0.06-0.08-0.10	(S=7073 rpm) 0.08-0.10-0.12	emulsion	
Carbon steel C>0.3%	50-60-70	(S=17825 rpm) 0.02-0.03-0.05	(S=11940 rpm) 0.03-0.04-0.05	(S=9549 rpm) 0.03-0.04-0.05	(S=7639 rpm) 0.06-0.08-0.10	(S=6063 rpm) 0.08-0.10-0.12	emulsion	
Low alloy steel C<0.3%	45-55-65	(S=14005 rpm) 0.01-0.02-0.04	(S=10950 rpm) 0.02-0.03-0.05	(S=8753 rpm) 0.02-0.03-0.05	(S=7002 rpm) 0.04-0.06-0.08	(S=5557 rpm) 0.06-0.08-0.10	emulsion	
High alloy steel C>0.3%	40-50-60	(S=12732 rpm) 0.01-0.02	(S=9950 rpm) 0.01-0.02-0.04	(S=7957 rpm) 0.01-0.02-0.04	(S=6366 rpm) 0.02-0.04-0.06	(S=5052 rpm) 0.04-0.06-0.08	emulsion	
Stainless Steel	5-10-20	(S=2546 rpm) 0.003-0.01	(S=1592 rpm) 0.005-0.02	(S=1592 rpm) 0.01-0.02	(S=1270 rpm) 0.01-0.02-0.03	(S=1010 rpm) 0.02-0.03-0.05	emulsion internal>5 bar	
Cast iron	50-60-70	(S=15278 rpm) 0.01-0.02-0.04	(S=11940 rpm) 0.02-0.04-0.06	(S=9549 rpm) 0.02-0.04-0.06	(S=7639 rpm) 0.04-0.06-0.08	(S=6063 rpm) 0.06-0.08-0.10	dry	
Al, and non-ferrous metal	100-150 -200	(S=38197 rpm) 0.01-0.02-0.03	(S=29850 rpm) 0.01-0.02-0.04	(S=23873 rpm) 0.01-0.02-0.04	(S=19098 rpm) 0.02-0.03-0.05	(S=15157 rpm) 0.02-0.04-0.06	emulsion	

► $\varnothing 5 \sim \varnothing 10$ (#6~#10) >>

Work piece material	Vc (m/min.)	f d1	f (mm/rev)					Cutting fluid
			IC16		IC20		IC25	
			$\varnothing 4$ (#5)	$\varnothing 5$	(#6)	$\varnothing 6.3$ (#7)	$\varnothing 8$ (#8)	
Carbon steel C<0.3%	60-70-80	(S=5570 rpm) 0.08-0.12-0.14	(S=4456 rpm) 0.10-0.12-0.16	(S=3536 rpm) 0.10-0.14-0.16	(S=2785 rpm) 0.12-0.15-0.18	(S=2228 rpm) 0.14-0.18-0.20	emulsion	
Carbon steel C>0.3%	50-60-70	(S=4774 rpm) 0.08-0.12-0.14	(S=3819 rpm) 0.10-0.12-0.16	(S=3031 rpm) 0.10-0.14-0.16	(S=2387 rpm) 0.12-0.15-0.18	(S=1909 rpm) 0.14-0.18-0.20	emulsion	
Low alloy steel C<0.3%	45-55-65	(S=4376 rpm) 0.06-0.08-0.10	(S=3501 rpm) 0.08-0.10-0.12	(S=2778 rpm) 0.08-0.12-0.14	(S=2188 rpm) 0.10-0.14-0.16	(S=1750 rpm) 0.12-0.16-0.20	emulsion	
High alloy steel C>0.3%	40-50-60	(S=3978 rpm) 0.04-0.06-0.08	(S=3183 rpm) 0.06-0.08-0.10	(S=2526 rpm) 0.08-0.10-0.12	(S=1989 rpm) 0.10-0.14-0.16	(S=1591 rpm) 0.10-0.14-0.16	emulsion	
Stainless Steel	10-15-25	(S=1194 rpm) 0.02-0.04-0.06	(S=955 rpm) 0.02-0.04-0.06	(S=758 rpm) 0.04-0.06-0.08	(S=597 rpm) 0.04-0.06-0.08	(S=477 rpm) 0.05-0.07-0.10	emulsion internal>5 bar	
Cast iron	50-60-70	(S=4774 rpm) 0.06-0.08-0.10	(S=3819 rpm) 0.08-0.10-0.12	(S=3031 rpm) 0.08-0.12-0.14	(S=2387 rpm) 0.10-0.14-0.16	(S=1909 rpm) 0.12-0.16-0.18	dry	
Al, and non-ferrous metal	100-150 -200	(S=11936 rpm) 0.02-0.04-0.06	(S=9549 rpm) 0.04-0.06-0.08	(S=7578 rpm) 0.04-0.06-0.08	(S=5968 rpm) 0.06-0.08-0.10	(S=4774 rpm) 0.06-0.08-0.10	emulsion	

• Step-1

Loosen the screw



• Step-2

Hole in the back



• Step-3

Push out insert



• Step-4

Place new insert
Logo side up



Performance

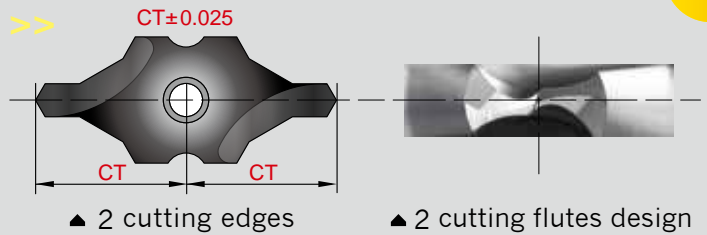

► Profit by making the right choice >>

- High speed and feed rate reduce cutting time.
- The unique design increases tool life and reduces change over time.



► Comparison >>

- Work piece : Low carbon alloy steel, 850 N/mm²
- Machine: VMC BT40 with internal coolant

Diameter of tool : Ø3.15 mm Depth of drilling : 7.2 mm				
Comparison		i-Center	HSS Center Drill (TiN Coating)	Solid Carbide Center Drill
Cutting speed	m/min.	65	17	65
Spindle speed	r.p.m.	6570	1718	6570
Feed rate f =	mm/rev.	0.12	0.02	0.1
Feed rate F=	mm/min.	788.4	34.4	657
Coolant	Emulsion	External / Internal	External	External
Drilling time	sec.	0.55	12.5	0.65
Holes of drilling per edge		7000	700	5000

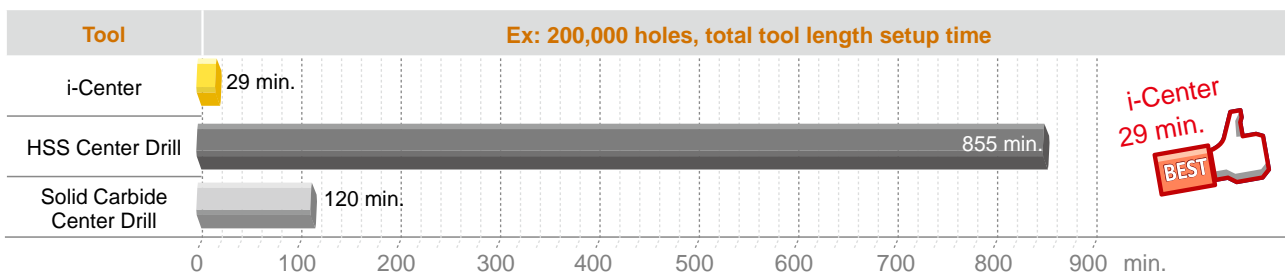
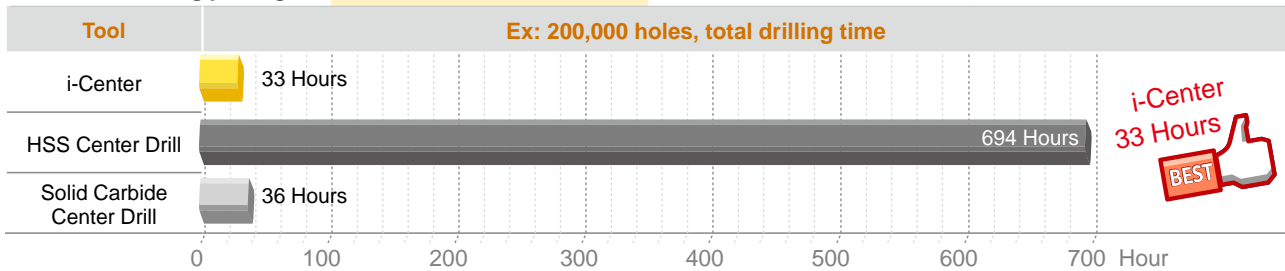

► Surface finish >>

i-Center Insert	Material SCM440		
I9MT1603B0500 NC2033	Vc	60	m/min.
	S	3800	r.p.m.
	f	0.1	mm/rev.
	F	380	mm/min.
	Ap	13.5	mm



```

Perthometer M1
Object
Name
#
Lt          5.630 mm
Ls standard 0.25 µm
Lc          0.830 mm
Ra          0.580 µm
Rz          3.26 µm
Rmax       0.51 µm
Rp(0.5, -0.5) 56 %
R Profile
Lc          0.800 mm
VER        2.50 µm
    
```



Application of i-Center >> Special holder

▶ Combined centering, facing chamfering and external turning >>

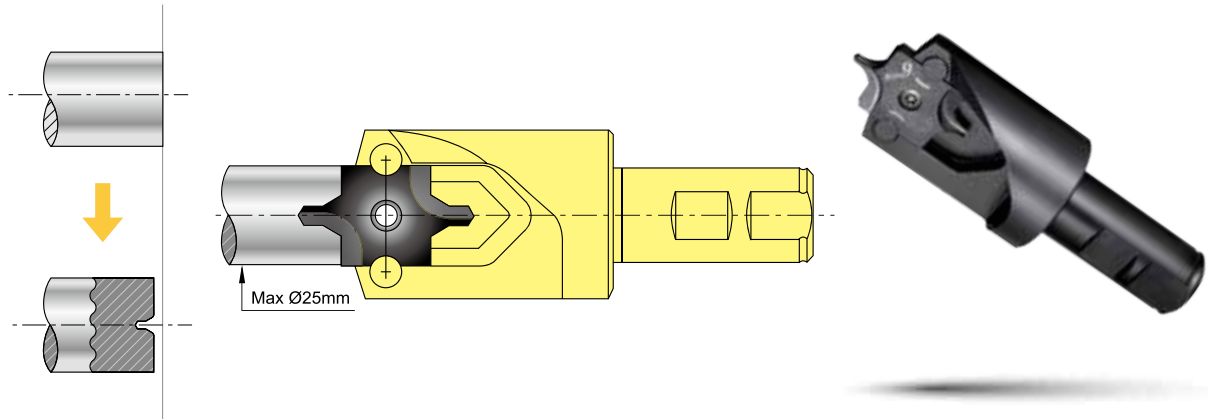

▶ Combined centering and facing >>

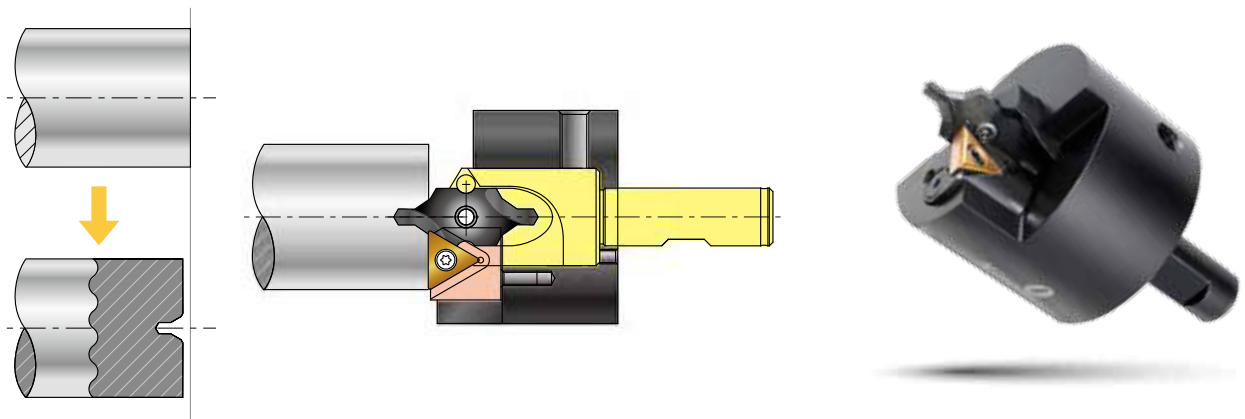

▶ Special 25x25 square shank holder >> Parts NO. 99616-IC 12 -L2525M 99616-IC 16 -R2525M

*For used on lathe

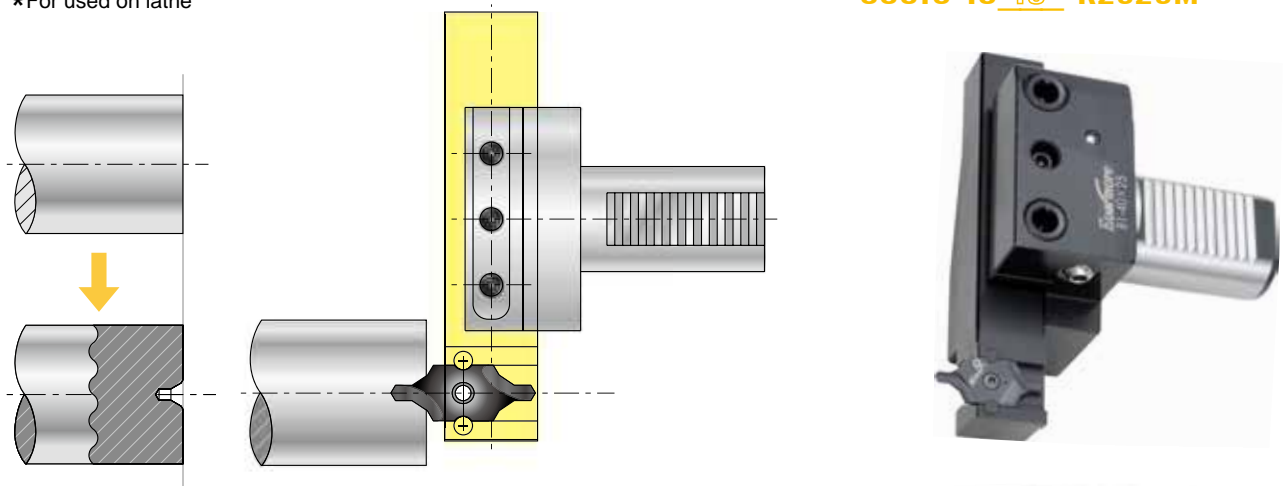

Technical Specifications

► 60° Centre holes DIN 332 >> Form R, A and B

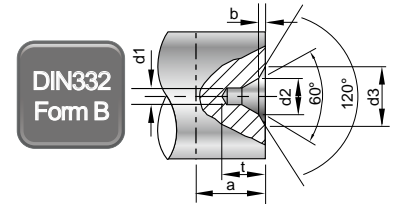
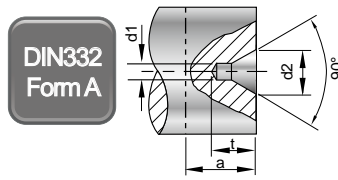
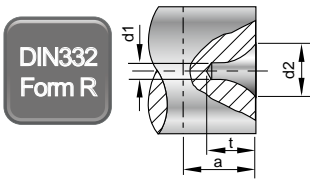

STD	DIN332 Form R ISO 2541-1972			DIN332 Form A ISO 866-1975			DIN332 Form B ISO 2540 1973					
	d1	d2	t	a	d2	t	a	d2	b	d3	t	a
1		2.12	1.9	3	2.12	1.9	3	2.12	0.3	3.15	2.2	3.5
1.25		2.65	2.3	4	2.65	2.3	4	2.65	0.4	4	2.7	4.5
1.6		3.35	2.9	5	3.35	2.9	5	3.35	0.5	5	3.4	5.5
2		4.25	3.7	6	4.25	3.7	6	4.25	0.6	6.3	4.3	6.6
2.5		5.3	4.6	7	5.3	4.6	7	5.3	0.8	8	5.4	8.3
3.15		6.7	5.8	9	6.7	5.9	9	6.7	0.9	10	6.8	10
4		8.5	7.4	11	8.5	7.4	11	8.5	1.2	12.5	8.6	12.7
5		10.6	9.2	14	10.6	9.2	14	10.6	1.6	16	10.8	15.6
6.3		13.2	11.4	18	13.2	11.5	18	13.2	1.4	18	12.9	20
8		17	14.7	22	17	14.8	22	17	1.6	22.4	16.4	25
10		21.2	18.3	28	21.2	18.4	28	21.2	2	28	20.4	31

► Advantage of Form R Center hole

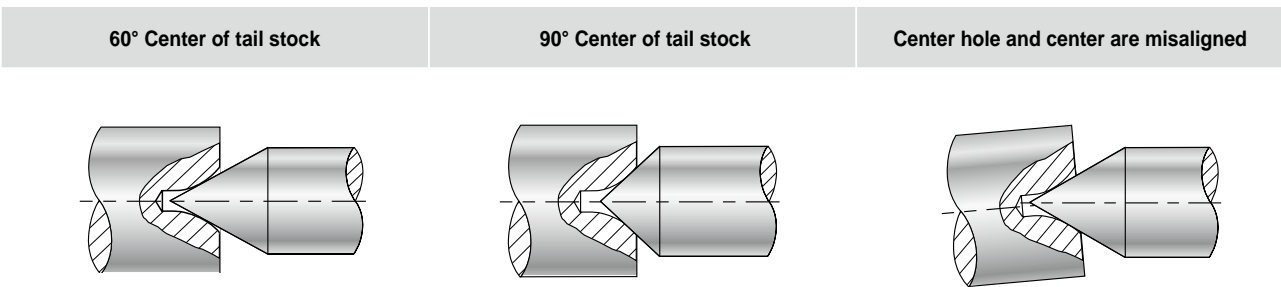

► Advantage of Form B center hole

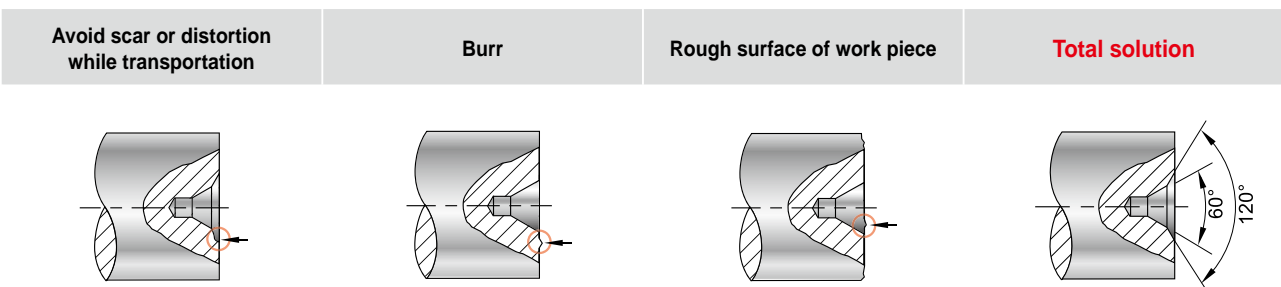

i-Center Applications

► Tip >>

- Various centering applications and products - shafts of engine, transmission gear boxes, bearings, motors, grinding parts, spindles, gear reducers, cooling fan, universal joints...
- Special forms for other application also available on request.

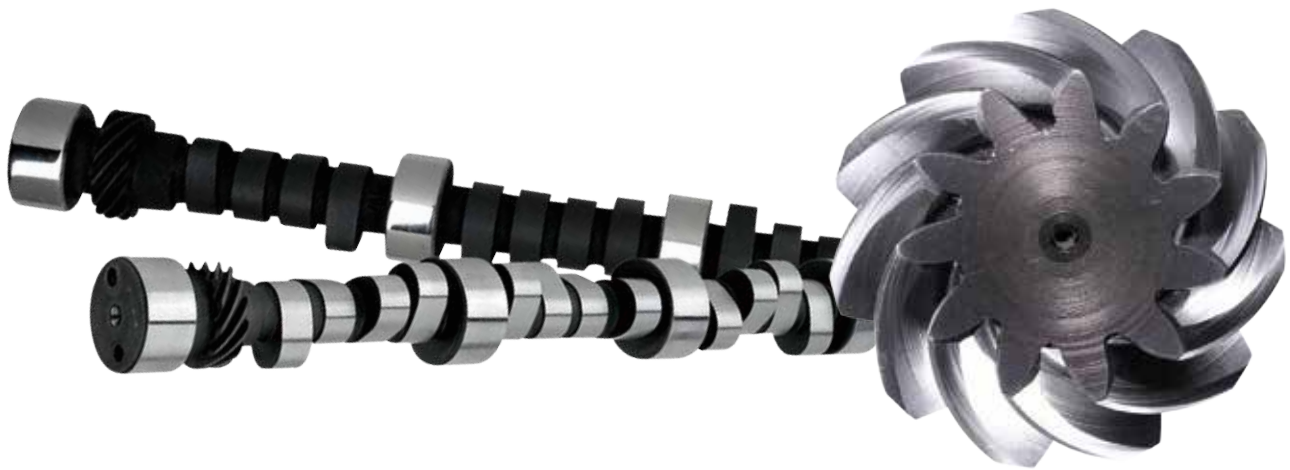

i-Center Enquiry Form

► Company >>

► Challenge or improvement >>

The following information should be checked while discussing with customer.

Machine	
Machine Type	
Spindle Speed	Max. r.p.m.
Power of Spindle motor	<input type="checkbox"/> KW <input type="checkbox"/> HP
Coolant supply	<input type="checkbox"/> NO <input type="checkbox"/> If yes, <input type="checkbox"/> External <input type="checkbox"/> Internal bar(psi)
Current tool	
Cutting Speed	<input type="checkbox"/> HSS <input type="checkbox"/> Solid Carbide m/min. SFM
Others	
Feed Rate	mm/rev. inch/rev.
Work Piece	
Material code	
Center hole type	<input type="checkbox"/> R <input type="checkbox"/> A <input type="checkbox"/> B <input type="checkbox"/> C <input type="checkbox"/> Other as attached drawing
Other request	<input type="checkbox"/> Surface roughness <input type="checkbox"/> Tolerance(see below)

► Special Tool holder shank dimensions >>

- Special tool holder shank, please fill in D1 and L4.
- As attached drawing.
- Metric Inch

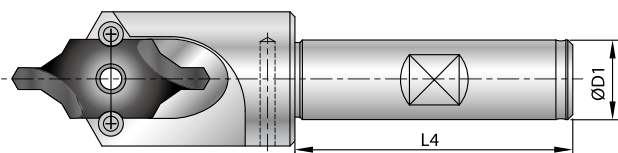

► Center hole dimension >>

- Please provide workpiece drawing
- One of following type should be chosen.

Type R

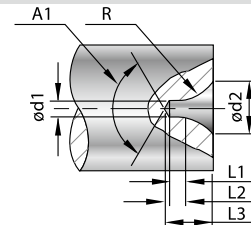

Type A

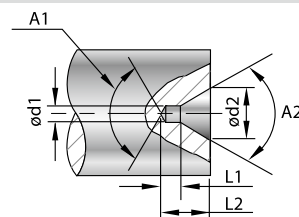

Type B

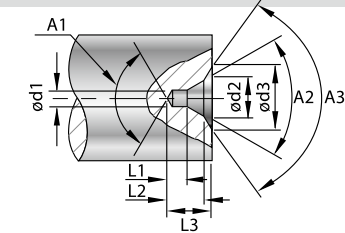

Type C

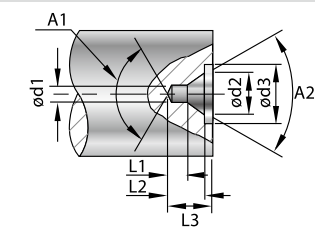

Other

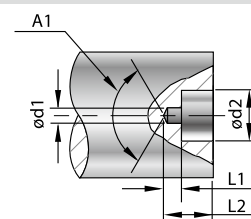

Dimension Table	A1	A2	A3	ød1	ød2	ød3
Dimension						
Tolerance	---	+0° -1°	±1°	±0.05	±0.05	---

Dimension Table	L1	L2	L3	R	ød1	L4
Dimension						
Tolerance	±0.05	±0.05	±0.05	±0.5	h6	---

i-Center



Engraving 45° / 60° >>

This is a revolutionary new concept of engraving tools with indexable carbide inserts. They offer you the ability to produce HIGH QUALITY ENGRAVING in most materials. The latest coated carbide grades help you to obtain higher speed and feed rate, dramatically reducing your cycle time.

Features

► High Positive Rake Angle

- Indexable insert.
- Suitable for engraving all types of materials, such as plastic, non-ferrous metal, aluminum, copper carbon steel and stainless steel.

► Multi-Side Grinding

- Full peripherally ground insert to ensure efficient repeatability.
- It performs excellently without producing any burrs, especially in copper, aluminum and stainless steel.

► High Speed, High Feed Rate

- Designed to run at high speed, up to 40,000 r.p.m.
- Feed rate 0.08mm (0.003") / rev. apply to aluminum;
0.05mm (0.002") / rev. apply to stainless steel.
- Reduces engraving cycle time!

► Economical

- Each indexable insert has 2 cutting edges.
- No resharpening required. Tool length is unchanged.
- No need to reset after changing insert or cutting edge.
- Excellent repeatability!

► Applications

- Serial numbers, product codes, dial scales, signs, logo, graph and almost any character which can be created by the NC programming system.



Serial number

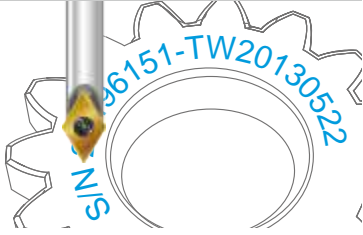

Logo outlines

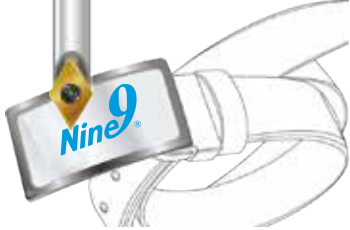

Mold & Die

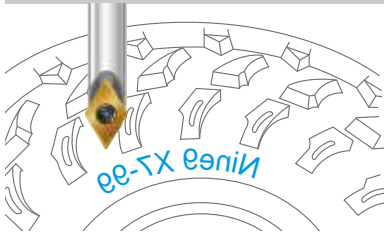

Product info

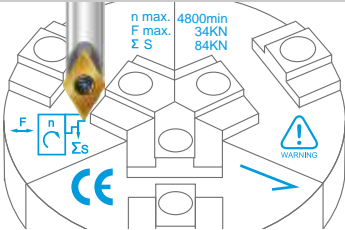

Dial scales

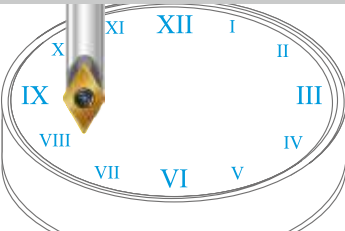

- ▲ Widely be used for marking on machine components, medical components, gun components, mold and die, automotive parts, gears, bearings and luxury goods.

Engraving Tool 45°

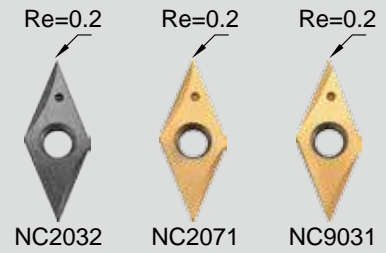

▶ Inserts >>

- NC2032:**
 - Long tool life
 - For all kind of steel from 30–50 HRC, carbon steel, alloy steel, and cast iron.
- NC2071:**
 - Strong edge on chip groove best suited for min. DOC 0.2 mm
 - Universal grade for all kind of steel <30HRC, non-ferrous metal and stainless steel.
- NC9031:**
 - Fully positive ground rake angle, very sharp edge for shallow engraving.
 - For non-ferrous metal such as aluminum, brass, copper, titanium, plastic and acrylic.

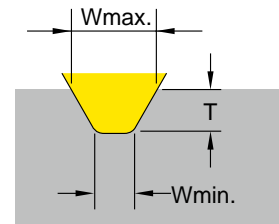

Code	Part No.	Angle	Grade	Coating	Re	Dimensions			W		T	
						L	S	Re	Wmin.	Wmax.	Tmin.	Tmax.
0104501	V04506T1W06-NC2071	45°	K20F	TiN		6.35	2.0	0.2	0.65	2.1	0.20	2.0
0104502	V04506T1W06-NC2032			TiAlN		0.65	0.20					
0104504	V04506T1W06-NC9031			TiN		0.45	0.05					

▶ Holder >>

- * • Carbide shank holders designed for shrink-fit holder, engraving machines, high speed cutting.
- * • XL (100mm length) is only for Al, Al-alloy cutting, unbalanced <0.6gm.



Code	Parts No.	Angle	Ød	L	L1	Screw / Key
691001	00-99619-V045-06	45°	6	40	---	 NS-22044 0.9Nm NK-T7
* 691002	00-99619-V045-06L			60	---	
* 691003	00-99619-V045-06XL			100	---	

Note: • DC Slim chuck, see page 68.

▶ Starter Kit >>

Code	Part No.	Shankø	Angle	Insert included	Content
691201-4501	00-99619-V045-03K-71	Ø6	45°	V04506T1W06-NC2071	1 x Holder 1 x T7 Key 3 x inserts
691201-4502	00-99619-V045-03K-32			V04506T1W06-NC2032	
691201-4504	00-99619-V045-03K-31			V04506T1W06-NC9031	
692201-6001	00-99619-V060-03K-71	Ø6	60°	V06006T1W06-NC2071	
692201-6002	00-99619-V060-03K-32			V06006T1W06-NC2032	
692201-6003	00-99619-V060-03K-35			V06006T1W06-NC2035	
692201-6004	00-99619-V060-03K-31			V06006T1W06-NC9031	



Engraving Tool 60°

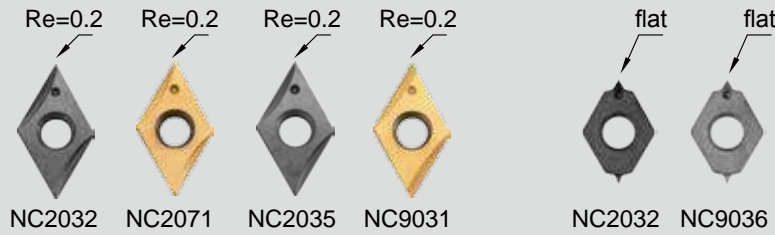

▶ Inserts >>

- NC2032:**
 - Long tool life
 - For all kind of steel from 30~50 HRC, carbon steel, alloy steel, and cast iron.
- NC2071:**
 - Strong edge on chip groove best suited for min. DOC 0.2 mm
 - Universal grade for all kind of steel <30HRC, non-ferrous metal and stainless steel.
- NC2035:**
 - ALDURA coating, reduce the heat and tool wear.
 - For steel with heat treatment up to 56 HRC.
- NC9031:**
 - Fully positive ground rake angle very sharp edge for shallow engraving.
 - For non-ferrous metal such as aluminum, brass, copper, titanium, plastic and acrylic.
- NC9036:**
 - DLC coating, very sharp edge produces excellent surface finish.
 - For non ferrous metal such as aluminum, brass, copper, titanium, plastic and acrylic.

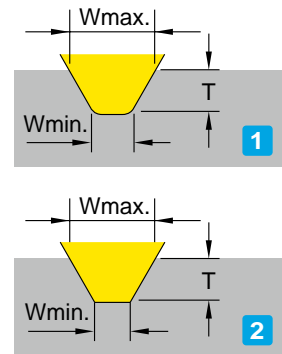
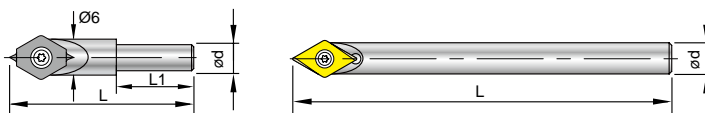

Fig	Code	Part No.	Angle	Grade	Coating	Dimensions			W		T	
						L	S	Re	Wmin.	Wmax.	Tmin.	Tmax.
1	0106001	V06006T1W06-NC2071	60°	K20F	TiN	6.35	2.0	0.2	0.65	2.7	0.20	2.0
1	0106002	V06006T1W06-NC2032			TiAlN				0.65		0.20	
1	0106003	V06006T1W06-NC2035			ALDURA				0.65		0.20	
1	0106004	V06006T1W06-NC9031			TiN				0.45		0.05	
Fig	Code	Part No.	Angle	Grade	Coating	Dimensions			W		T	
						L	S	Re	Wmin.	Wmax.	Tmin.	Tmax.
2	0106006	V06006T1W03-NC2032	60°	K20F	TiAlN	6.35	2.0	---	0.25	1.1	0.05	0.8
2	0106007	V06006T1W03-NC9036			DLC							

▶ Holder >>

- Carbide shank holders designed for shrink-fit holder, engraving machines, high speed cutting.
- XL (100mm length) is only for Al, Al-alloy cutting, unbalanced <0.6gm.



Code	Parts No.	Angle	Ød	L	L1	Screw / Key
692004	00-99619-V060-04	60°	4	30	12	 NS-22044 0.9Nm NK-T7
692001	00-99619-V060-06		6	40	---	
* 692002	00-99619-V060-06L		6	60	---	
* 692003	00-99619-V060-06XL		6	100	---	

Engraving Tool

Cutting Data

▶ Engraving Depth and Width Reference Chart

- To use the engraving chart, select your engraving width (w) on the vertical axis. Select your engraving insert angle (45° or 60°), and follow the horizontal line from the (w) axis to the intersection with the insert angle.
- Follow the vertical line from this intersection point to the engraving depth (t) axis to determine the engraving depth.

▶ V045/V060 T1W06 >>

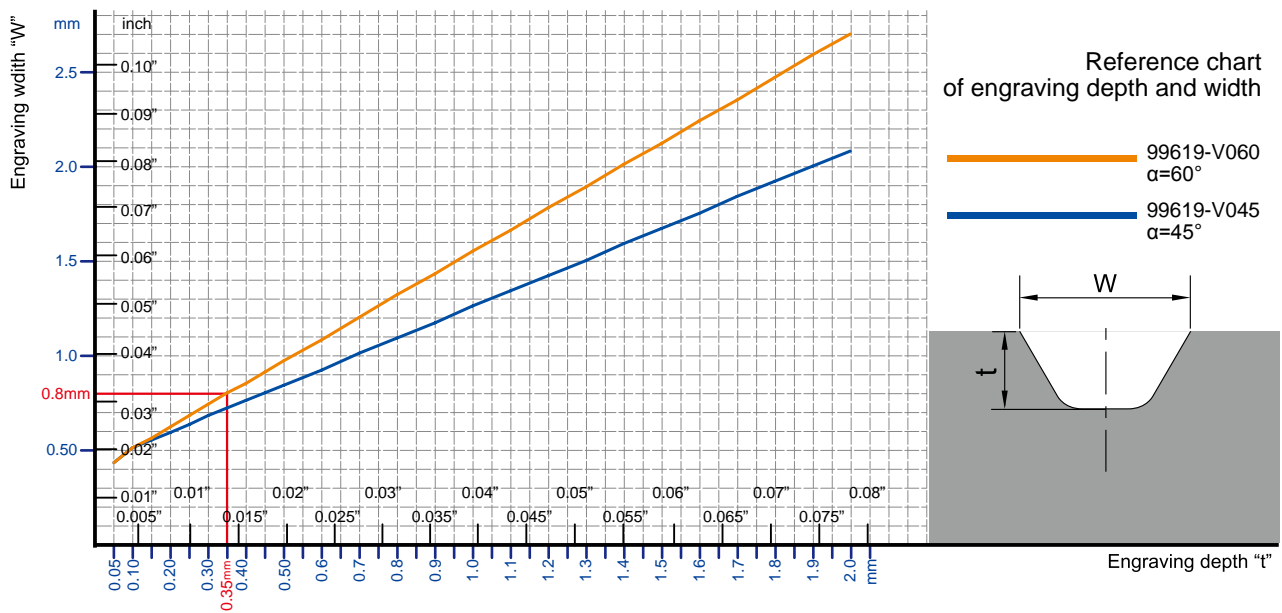

Work Material	S RPM	f (mm/rev.)	Grade of Insert
Carbon steel	5000~40000	0.008~0.05	NC2071,NC2032
Alloy steel	5000~40000	0.008~0.03	NC2032,NC2071
Alloy steel \geq HRC40°~56°	5000~40000	0.008~0.02	NC2035
Stainless Steel	5000~40000	0.008~0.05	NC2071,NC9031
Cast iron	5000~40000	0.008~0.03	NC2032
Aluminum \geq Non-Ferrous Metal	5000~40000	0.008~0.08	NC2071,NC9031

Tmax.:2mm

Material	Ap	Tmax.:2mm							Fine finishing
		1st	2nd	3rd	4th	5th	6th	~	
Carbon steel		0.8	0.6	0.3	0.2	0.1	~	~	0.1
Alloy steel		0.5	0.4	0.3	0.3	0.2	0.2	0.1	0.1
Alloy steel \geq HRC40°~56°		0.2	0.2	0.15	0.15	0.1	0.1	0.1	0.05
Stainless Steel		0.5	0.4	0.3	0.3	0.2	0.2	0.1	0.05
Cast iron		0.8	0.6	0.3	0.2	0.1	~	~	0.1
Aluminum \geq Non-Ferrous Metal		1.0	0.8	0.2	~	~	~	~	0.1

Cutting Data

▶ V060 T1W03 >>

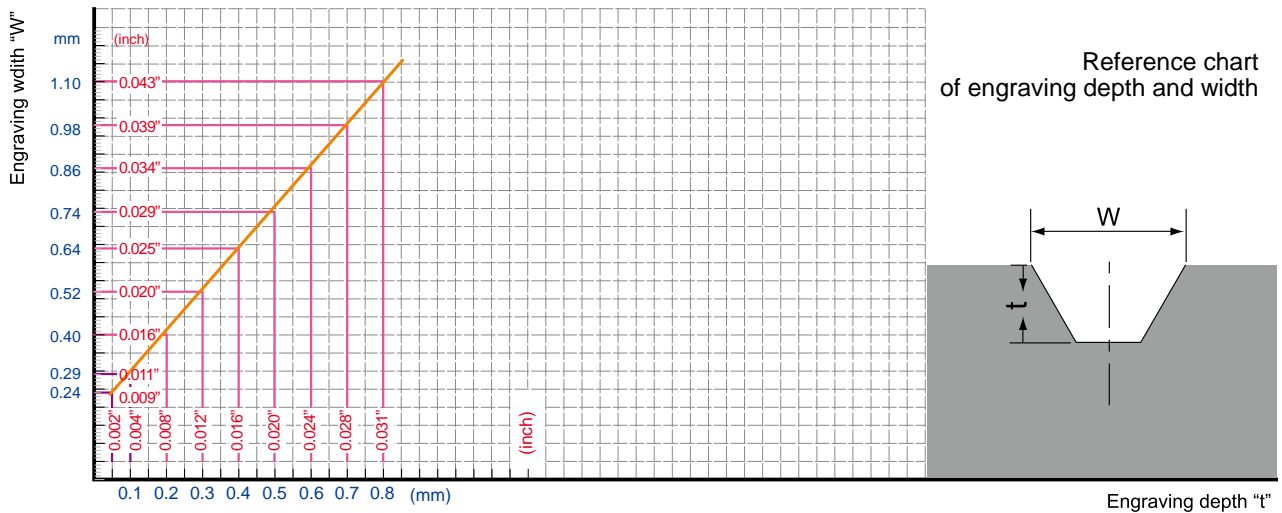

Work Material	S RPM	f (mm/rev.)	Grade of Insert
Carbon steel C<0.3%	5000 ~ 40000	0.005 ~ 0.01	NC2032
Carbon steel C>0.3%	5000 ~ 40000	0.005 ~ 0.015	NC2032
Alloy steel	5000 ~ 40000	0.005 ~ 0.01	NC2032
Stainless Steel	5000 ~ 40000	0.005 ~ 0.01	NC9036
Cast iron	5000 ~ 40000	0.005 ~ 0.015	NC2032
Aluminum	5000 ~ 40000	0.005 ~ 0.015	NC9036
Copper, Brass	5000 ~ 40000	0.005 ~ 0.01	NC9036
Titanium	5000 ~ 40000	0.005 ~ 0.015	NC9036

Tmax.:0.8mm

Material	Ap	Tmax.:0.8mm						
		1st	2nd	3rd	4th	5th	~	Fine finishing
Carbon steel C<0.3%		0.3	0.2	0.1	0.1	0.05	0.05	0.03
Carbon steel C>0.3%		0.3	0.2	0.1	0.1	0.05	0.05	0.03
Alloy steel		0.3	0.1	0.1	0.05	0.05	0.05	0.03
Stainless Steel		0.2	0.1	0.1	0.1	0.05	0.05	0.03
Cast iron		0.2	0.1	0.1	0.1	0.05	0.05	0.03
Aluminum		0.2	0.1	0.1	0.1	0.05	0.05	0.03
Copper, Brass		0.2	0.1	0.1	0.1	0.05	0.05	0.03
Titanium		0.2	0.1	0.1	0.1	0.05	0.05	0.03

Engraving Tool

Engraving X060 >>

Custom forms based on your specification of angle, width, depth and corner radius

NEW

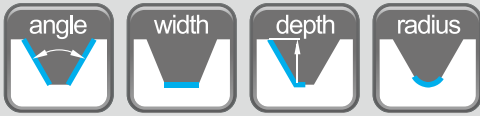

► One holder supports the entire X060 series >>

- Minimum width of bottom : 0.1mm.
- Angles from 10° up to 120°.
- Replace solid carbide engraving tool.

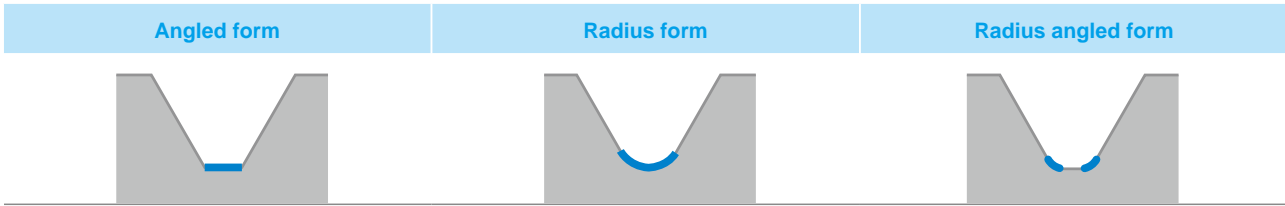

Unlimited variations : The X060 insert will be designed based on your specific application of angle, width, depth and radius.

Inserts Grade	Carbide	Coating	Material	P	M	K	N	H	S
NC2071	K20F	TiN	For all kind of steel < 30 HRC.	⊙	●		⊙		
NC2032	K20F	TiAlN	For all kind of steel from 30-50HRC, carbon steel, alloy steel and casting iron.	●	○	●			
NC2035	K20F	ALDURA	For steel with heat treatment up to 56 HRC.	⊙		○		●	
NC9036	K20F	DLC	For non-ferrous metal, Al, Al-alloy, Brass, copper and long cutting chip metal.		⊙		●		⊙
NP9001	K20F	—	Uncoated fine polishing insert		⊙		●		⊙

Angled form	Developed Non-Stock	Angle	Coating	Re	Bottom width	Depth	P	M	K	N	H	S
	X060A30W100S-NC2032	30°	TiAlN	-	1.0	1.0	●	○	●			
	X060A30W030S-NC2032				0.3	2.0	●	○	●			
	X060A30W051S-NC2032				0.508	2.0	●	○	●			
	X060A50W007S-NP9001	50°	—	—	0.07	1.0		⊙		●		⊙
	X060A60W010S-NC2032	60°	TiAlN	-	0.1	0.5	●	○	●			
	X060A60W010S-NC9036		DLC	-	0.1	0.5		⊙		●		⊙
	X060A60W020S-NC2032		TiAlN	-	0.2	1.2	●	○	●			
	X060A60W020S-NC9036		DLC	-	0.2	1.2		⊙		●		⊙
	X060A60W030S-NC2032		TiAlN	-	0.3	2.0	●	○	●			
	X060A60W030S-NC9036		DLC	-	0.3	2.0		⊙		●		⊙

Radius form	Developed Non-Stock	Angle	Coating	Re	Bottom width	Rmax. Depth	Depth	P	M	K	N	H	S
	X060A30R010-NC9036	30°	DLC	0.1	0.2	0.07	2.0		⊙		●		⊙
	X060A60R010-NC2035	60°	ALDURA	0.1	0.2	0.05	0.5	⊙		○		●	
	X060A60R040-NC2035		ALDURA	0.4	0.7	0.2	1.0	⊙		○		●	
	X060A60R040-NC2071		TiN	0.4	0.7	0.2	1.0	⊙	●		⊙		
	X060A60R050-NC2035	ALDURA	0.5	0.9	0.25	1.0	⊙		○		●		
	X060A90R010-NC2035	90°	ALDURA	0.1	0.14	0.03	1.0	⊙		○		●	

● Best ⊙ Suit ○ Possible

Patent Pending

► Features >>

- Full peripherally ground insert to ensure accurate repeatability.
- Each insert has 2 cutting edge. Cost saving!
- High speed, high feedrate, reducing engraving cycle time.

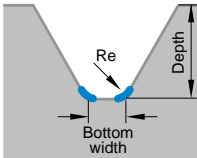
Radius angled form	Developed Non-Stock	Angle	Coating	Re	Bottom width	Depth	P	M	K	N	H	S			
	X060A30W040R-NC2032	30°	TiALN	0.08	0.4	2.0	●	○	●						
	X060A30W040R-NC9036		DLC	0.08	0.4	2.0		◎		●		◎			
	X060A45W010R-NC2035	45°	ALDURA	0.02	0.1	1.5	◎		○		●				
	X060A45W040R-NC2032 (V04506T1W06-NC2032)		TiALN	0.08	0.4	2.0	●	○	●						
	X060A45W040R-NC9036		DLC	0.08	0.4	2.0		◎		●		◎			
	X060A60W010R-NC2032 (N9MT080201W-60-NC40)	60°	TiALN		0.02	0.1	1.0	●	○	●					
	X060A60W013R-NC2032				0.03	0.127	2.0	●	○	●					
	X060A60W020R-NC2032 (V06006T1W03-NC2032)				0.04	0.2	1.2	●	○	●					
	X060A60W030R-NC2032				0.06	0.3	1.0	●	○	●					
	X060A60W038R-NC2032				0.08	0.380	2.0	●	○	●					
	X060A60W040R-NC2032 (V06006T1W06-NC2032)				0.08	0.4	2.0	●	○	●					
	X060A60W040R-NC9036			DLC	0.08	0.4	2.0		◎		●		◎		
	X060A60W051R-NC2032			TiALN	0.10	0.508	2.0	●	○	●					
	X060A90W010R-NC2032 (N9MT080201W-NC10)			90°	TiALN		0.02	0.1	0.7	●	○	●			
	X060A90W030R-NC2032						0.06	0.3	0.5	●	○	●			

● Best ◎ Suit ○ Possible

► Holder >>

- Carbide shank is ground to h6 tolerance, unbalanced <0.6gm.
- Made of high alloy steel and brazed on a carbide shank.
- Provides high rigidity and anti-vibration
- One holder supports the entire X060 series of engraving inserts.

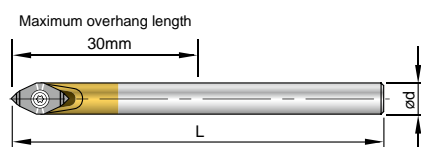

Code	Parts No.	Ød	L	Screw	Key
00-99619-X060-06L	BC06-CT-X060-60L	6	60	NS-22044 0.9Nm	NK-T7

► Attention >>

- Using high precision tool holder to make sure run out of whole tool is below 0.01 mm on the tool holder.
- High precision collect chuck, shrink fit chuck and hydraulic chuck are recommended.

X060 Enquiry Form

NEW

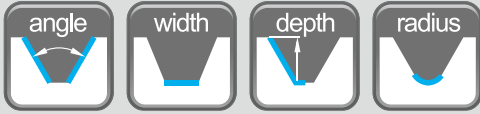

► **Enquiry Example >>**

X060 A 30 W 030 S - NC2032

Series	Angle	Bottom Form	Bottom Width	Depth	Corner Shape	Insert Grade
X060	A 30 from 10°~120°	<input checked="" type="checkbox"/> W <input type="checkbox"/> R	030	T 0.05	<input checked="" type="checkbox"/> S Flat <input type="checkbox"/> R Radius	<input checked="" type="checkbox"/> NC2032 <input type="checkbox"/> NC2035 <input type="checkbox"/> NC9036 <input type="checkbox"/> NP9001

Comment

Angle	From 10° up to 120°	Depth	Depth of engraving
Bottom Form	W for flat shape or R for radius shape	Corner Shape	S for flat shape or R for radius shape
Bottom Width	Bottom Width of engraving. Minimum width of bottom : 0.1 mm or 0.005"	Grade	Refer to previous page

► **Example >>**

Angled form	+	Angle	Bottom Form	Bottom Width	Corner Shape	+	Angle	Bottom Form	Bottom Width	Corner Shape		
		30°	W	0.30	S		60°	W	1.20	S		
		A30W03S					A60W12S					
Radius angled form	+	Angle	Bottom Form	Bottom Width	Corner Shape	Re	+	Angle	Bottom Form	Bottom Width	Corner Shape	Re
		60°	W	0.10	R	0.02		30°	W	0.30	S	0.02
		A60W01R					A60W05R					
Radius form	+	Angle	Bottom Form	Radius	+	Angle	Bottom Form	Radius				
		60°	R	0.10		60°	R	0.50				
		A60R010				A60R050						

NC De-Burring

Patent Pending

NEW



► Features >>

- High feed rate for high speed de-burring on CNC machines.
- Indexable type ensure the relative position of de-burring.

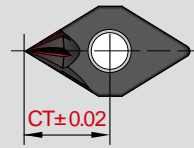

NC2032

► Inserts >>

- Smallest counter sink diameter $\varnothing 0.5$ mm.
- Ideal for fine hole de-burring.
- Each insert has one cutting edge.
- Using same tool holder of X060 engraving tool.
- Indexable type. Relative position of deburring depth and diameter are accurate.
- TiAlN coated carbide insert can stand very long life.

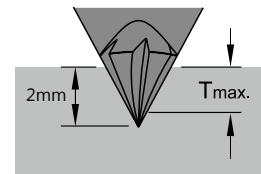

Code	Part No.	Angle	Grade	Coating	Diagram	C		Dimensions			Tmax.
						Cmin.	Cmax.	L	S	Re	
01X601	X060A60T6-NC2032	60°	K20F	TiAlN		0.1	1.0	6	2.0	--	1.6
01X901	X060A90T6-NC2032	90°				0.1	1.2	6	2.0	--	1.75

60 degree

90 degree

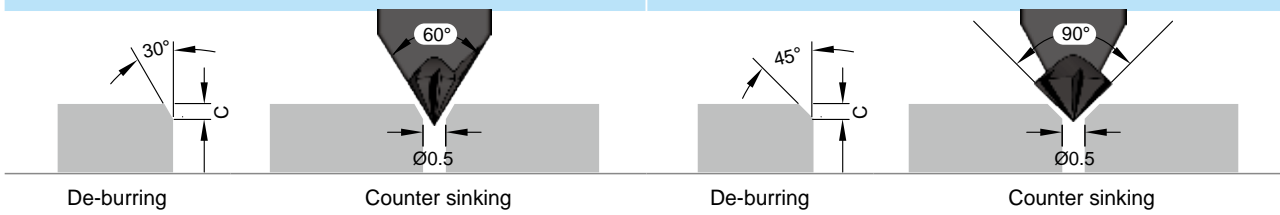

► Holder >>

- Carbide shank is ground to h6 tolerance.
- Made of high alloy steel and brazed on a carbide shank.
- Provides high rigidity and anti-vibration.

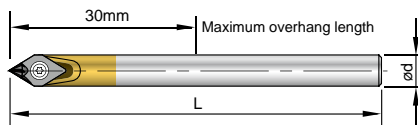

Code	Parts No.	Ød	L	Screw	Key
69X002	00-99619-X060-06L	6	60	NS-22044 0.9Nm	NK-T7

► Attention >>

- Using high precision tool holder to make sure run out of tool shank is below 0.01 mm.
- High precision collect chuck, shrink fit chuck and hydraulic chuck are recommended.

► Starter Kit >>





Code	Part No.	Shankø	Angle	Insert included	Content
69X202-X601	00-99619-X060-DB60-02K-32	6	60°	X060A60T6-NC2032	1 x Holder 1 x T7 Key 2 x inserts
69X202-X901	00-99619-X060-DB90-03K-32		90°	X060A90T6-NC2032	



NC De-Burring

Performance

► Comparison >>

Tool				
		00-99619-V060-06 V06006T1W06-NC2071	Engraving tool	Ball nose end mill Radius 0.4 mm
Work piece material		Tool steel SKD 61 (JIS G 4404), Hardness: HRB92~93 (HB 200)		
Spindle speed	r.p.m.	10000	10000	10000
Feed rate	mm/min.	100	100	300
Cutting depth Ap		0.2 mm	0.2 mm	0.05 mm, 4 times to cut to 0.2 mm
Roughness of bottom Ra		0.36 μm	0.83 μm	0.46 μm
Change and resetting		No need	Need	Need
Tool life		Long	Short	Short
Measured result by Alicona IFM system				

Tool		00-99619-V060-06 V06006T1W06-NC2071	00-99619-V060-06 V06006T1W06-NC2071	00-99619-V060-06 V06006T1W06-NC2035
Work piece material		SKD 51	SS	SKD 61 (50HRC)
Spindle speed	r.p.m.	10000	10000	10000
Feed rate	mm/min.	300	300	100
Cutting depth Ap		0.1 mm	0.35 mm	0.2 mm
Change and resetting		No need	No need	No need
Tool life		24 min.(1440 sec.)	7.2 meters	3.5 meters

► Attention >>

- **Selecting the speed and feed rate**
 - Select the spindle speed and feed rate according to the selected material's cutting data.
 - The downward feed rate of the Z-axis should be reduced to **50%** of the table feed rate.
- **Cutting fluid and cooling condition**
 - Elmulsion is recommended for engraving on steel, stainless steel, Al and Al-alloy.
 - Blown cooled air is recommended for engraving on cast iron and plastic.
- **Setting-up the tool holder**
 - The tool shank runout should be below 0.01 mm.
 - Shrink fit chucks, hydraulic chuck and high precision spring collet chucks are recommended.
 - Pre-balance the tool holder minimum G6.3/10,000 R.P.M. is necessary.
- **Clamping the engraving insert**
 - Place and hold the insert in the insert pocket against the positioning side.
 - See illustration below:
 - Step-1
 - Step-2
 - Step-3

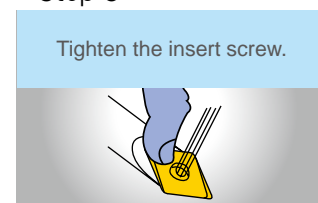
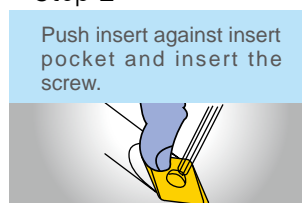
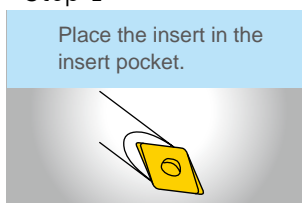

Engraving Applications

► Tip >>

Use the V045 and V060 style engravers in materials that tend to push burrs such as stainless steels and high temp alloys. These inserts have a 0.2mm(0.008") radius with a very sharp cutting edge and cut very freely. Character widths start around 0.45mm(0.017").

This tool best replaces ball nose endmills. This tool is considered to be first choice for all but fine engraving width below 0.25mm.

Components



Luxury goods



Mold & Die



Product



Engraving Tool



Chamfer Mill 45° >>

Nine9 chamfer mill

is designed for chamfering and countersinking with an indexable insert.

The insert is a specifically designed for use in high speed machining ; the multiple flutes provide for increased feed rate, optimizing performance and reducing cutting time.

Features

Ultra high speed and feed rate is the biggest advantage of Nine9 Chamfer Mills.

It is not a traditional chamfer tool, it runs 4 times faster in cutting speed and 10 times higher in feed rate. It is the most efficient tool you ever met.

► Excellent Repeatability >>

- Smallest insert in the world for chamfering mill.
- Smallest Indexable counter sink, diameter $\varnothing 7$ mm.
- The insert is dual-relief angle, specially edge honning and optimized coated for high cutting speed.
- Optimized the number of teeth on the holder to achieve higher feed rate.



► Applications >>

- 90° counter sink and 45° chamfering.
- For counter sink, circular chamfering, contour chamfering and face milling.



Smallest
in the world

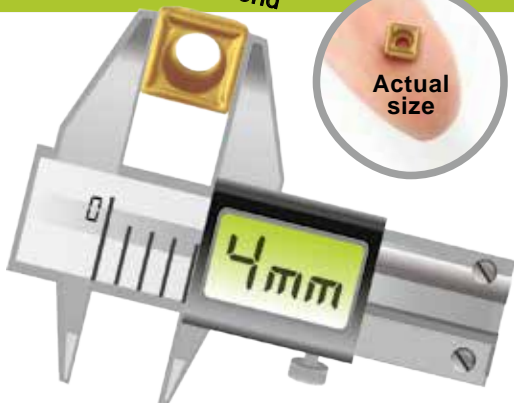

Face Milling

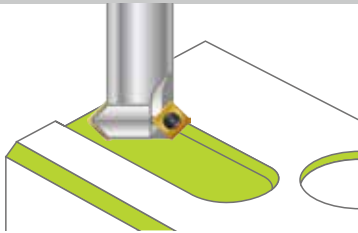

Chamfering

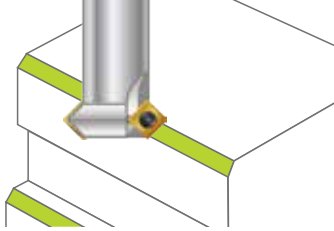

Back Chamfering

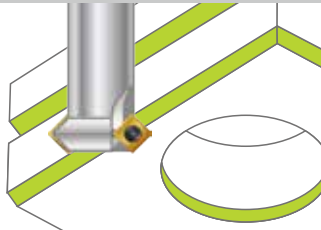

Countersink

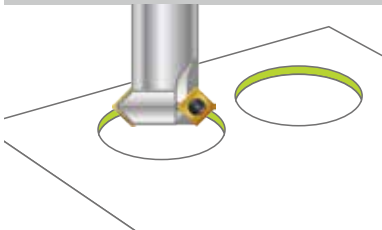

Back Circular Chamfering

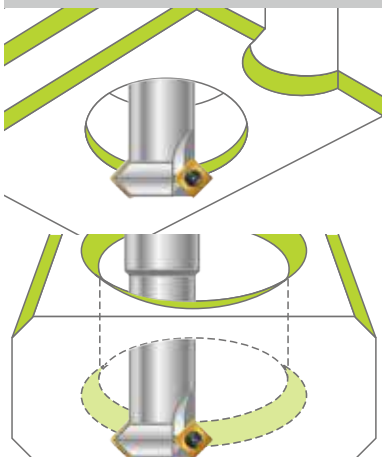

▲ For front and back chamfering.
Eliminates 2nd operation or de-burring time.

Indexable Chamfer Mill

► Features >>

- Benefitting from the specially ground dual-relief insert and optimized coating, higher feed rates and cutting speeds can be achieved on chamfering operations.
- Each insert has **4 cutting** edges, reducing cost of inserts.
- Fine edge honning cutting edge, good chip breaking condition and long tool life.

► 99616-C02, C04, C06 >>

- Made from hot working steel and hardened.
- Elliptical necked bar to optimize the tool strength.

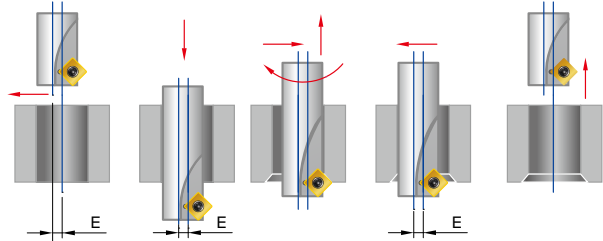
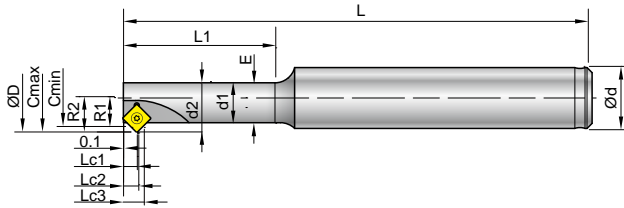

Parts No.	Type	Cmin ø	Cmax ø	ød	ød1	ød2	øD	R1	R2	L	L1	Lc1	Lc2	Lc3	E	z	insert Screw / Key
00-99616-C02	BC10-C02-80	6.8	8.8	10	5.25	6.5	9	3.4	4.4	80	20	2.56	2.93	3.93	1.25	1	N9GX04T002 NS-18037 0.6Nm NK-T6
00-99616-C04	BC12-C04-100	8.5	10.8	12	6.45	8	11.1	4.25	5.4	100	25	2.51	2.98	4.13	1.55	1	
00-99616-C06	BC12-C06-100	10.26	13.2	12	7.88	9.75	13.5	5.13	6.6	100	30	2.51	2.98	4.45	1.88	1	

► 99616-C10~99616-C52 >>

- Made from tool steel.

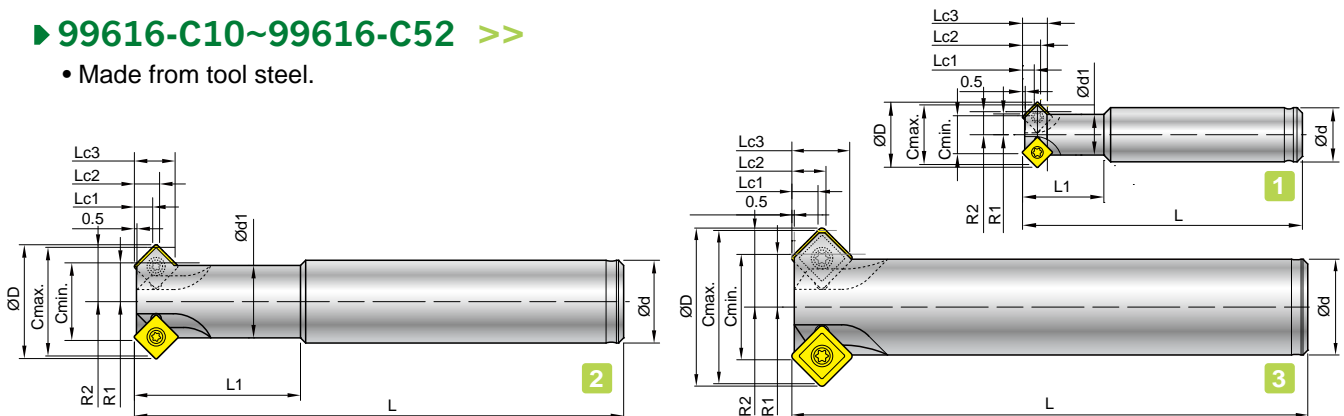

Fig	Parts No.	Type	Cmin ø	Cmax ø	ød	ød1	øD	R1	R2	L	L1	Lc1	Lc2	Lc3	z	insert Screw / Key
1	00-99616-C10	BC10-C07-60	7	11	10	7.5	12	3.8	4.3	60	15	2.6	2.9	4.6	2	N9GX04T002 NS-18037 0.6Nm NK-T6
	00-99616-C20	BC12-C11-100	11	16	12	9.6	16.2	5.9	8	100	25	2.6	2.9	5.0	4	
2	00-99616-C30	BC16-C15-120	15	21	16	14	22	7.5	11.5	120	40	3.5	4.9	7.9	4	N9GX060204 NS-22055 0.9Nm NK-T7
	00-99616-C40	BC20-C19-130	19	25	20	18	26	9.5	12.5	130	50	3.5	4.9	7.9	4	
3	00-99616-C50	BC20-C22-130	22	32	20	--	33	11	16	130	--	5.5	7.1	12.1	4	N9GX090308 NS-30072 2.0Nm NK-T9
2	00-99616-C52	BC25-C22-180	22	32	25	20	33	11	16	180	80	5.5	7.1	12.1	4	

► Starter Kit >>

Fig	Part No.	Insert included	Holder included	Content
1	00-99616-C1020-32	N9GX04T002-NC2032	00-99616-C10	2 x holders + 10 inserts + 1 key
	00-99616-C1020-71	N9GX04T002-NC9072	00-99616-C20	
2	00-99616-C3040-32	N9GX060204-NC2032	00-99616-C30	2 x holders + 10 inserts + 1 key
	00-99616-C3040-71	N9GX060204-NC9071	00-99616-C40	
3	00-99616-C5052-32	N9GX090308-NC2032	00-99616-C50	2 x holders + 10 inserts + 1 key
	00-99616-C5052-71	N9GX090308-NC9071	00-99616-C52	



► Inserts >>

- NC2032:**
- AlTiN coating, very long tool life.
 - For carbon steel, alloy steel, cast iron and hardened steel up to 56HRC
 - Each insert has 4 cutting edges.
- NC9071:**
- TiN coating, very sharp cutting edge produces excellent surface finish
 - For non ferrous metal, aluminum, aluminum-alloy, brass, copper and stainless steel.
 - Each insert has 4 cutting edges.

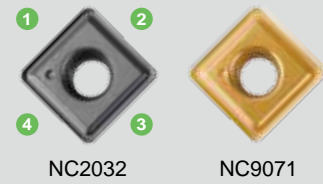

Parts No.		Coating	Dimensions	Dimensions				
Code of insert	Grade			L	S	Re	Screw	Key
N9GX04T002	NC2032	AlTiN		4.0	1.8	0.2	NS-18037 0.6Nm	NK-T6
	NC9071	TiN						
N9GX060204	NC2032	AlTiN		6.35	2.38	0.4	NS-22055 0.9Nm	NK-T7
	NC9071	TiN						
N9GX090308	NC2032	AlTiN		9.52	3.18	0.8	NS-30072 2.0Nm	NK-T9
	NC9071	TiN						

► 99616-C02, C04, C06 Cutting Data >>

Work Piece Material		Grade of insert	Cutting Speed VC m/min.	Feed Rate mm / tooth
Material Group	Sample Code (JIS)			N9GX04T002
Carbon steel C<0.3%	SS400	NC9071	60-80-120	0.02 ~ 0.07
Carbon steel C>0.3%	S50C, P5	NC2032	60-80-120	0.02 ~ 0.07
Low alloy steel C<0.3%	SCM420	NC9071	60-80-120	0.01 ~ 0.04
High alloy steel C>0.3%	SKD11	NC2032	60-80-120	0.02 ~ 0.07
Stainless Steel	SUS304	NC9071	30-60-100	0.01 ~ 0.04
Cast iron	FC25	NC2032	60-80-120	0.02 ~ 0.06
Al, and non-ferrous metal	A6061	NC9071	80-100-150	0.03 ~ 0.10

► 99616-C10~C52 Cutting Data >>

Work piece material		Grade of insert	Cutting Speed Vc m/min.	Feed rate mm / tooth		
Material Group	Sample Code (JIS)			N9GX04T002	N9GX060204	N9GX090308
Carbon steel C<0.3%	SS400	NC9071	150-250-350	0.06~0.12	0.10~0.25	0.10~0.25
Carbon steel C>0.3%	S50C,P5	NC2032	200-300-400	0.06~0.10	0.10~0.20	0.10~0.25
Low alloy steel C<0.3%	SCM420	NC9071	180-240-260	0.06~0.10	0.10~0.20	0.10~0.20
High alloy steel C>0.3%	SKD11	NC2032	120-150-200	0.06~0.10	0.10~0.15	0.10~0.15
Stainless Steel	SUS304	NC9071	120-150-180	0.06~0.10	0.06~0.15	0.10~0.20
Casting iron	FC25	NC2032	120-150-180	0.06~0.10	0.10~0.15	0.10~0.20
Al, and non-ferrous metal	A6061	NC9071	200-400-600	0.06~0.15	0.10~0.25	0.10~0.25
Hardened steel<HRC50°	SKD61	NC2032	80-90-100	0.06~0.10	0.06~0.12	0.10~0.15

Chamfer Mill

Performance

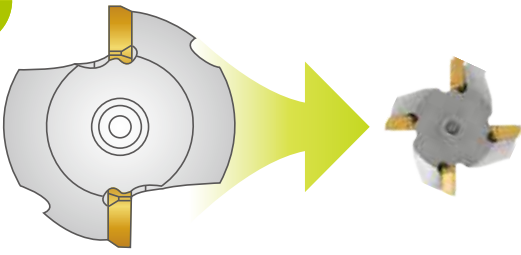



Feed Rate = Feed per Tooth x Spindle Speed x **No. of Flute** mm/min.

UP **Spindle Speed** = $\frac{\text{Cutting Speed} \times 1000}{\pi \times C \text{min.}}$

▶ Test Result >> Example 1

- Chamfer tool with larger insert(Sxxx1204) and Nine9 N9GX04 insert.

Tool			
Cutting data		Nine 9 Chamfer mills	Other makers with Large insert
Chamfering		1 mm	1 mm
Feed rate	mm/rev.	0.1	0.1
Dia. of cutter	mm	11	32
Teeth of cutter		4	2
Cutting Speed Vc	m/min.	300	200
Spindle Speed	r.p.m.	8685	1990
Feed rate	mm/min	3474	398

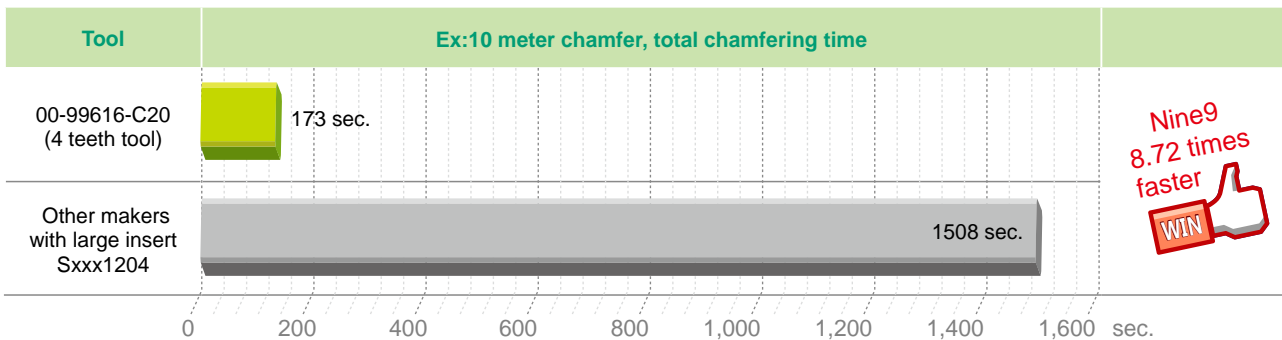
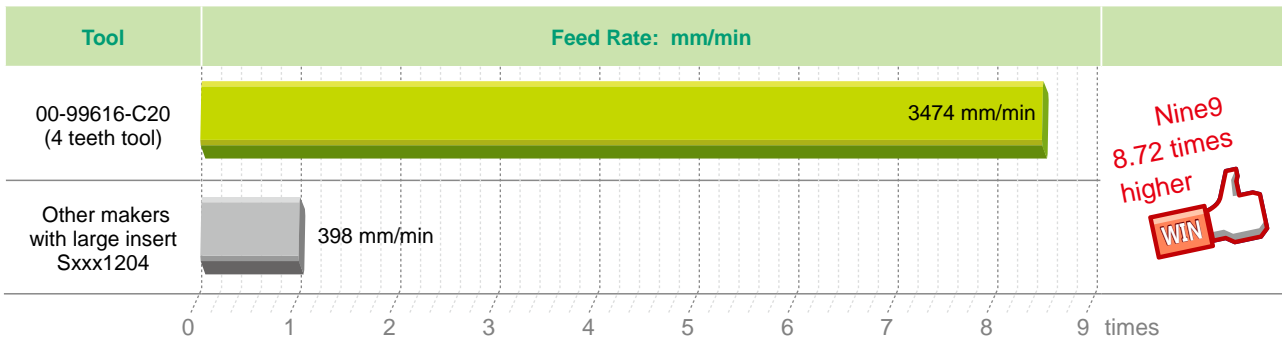

DC Slim Chuck

► Extension Adaptor >>

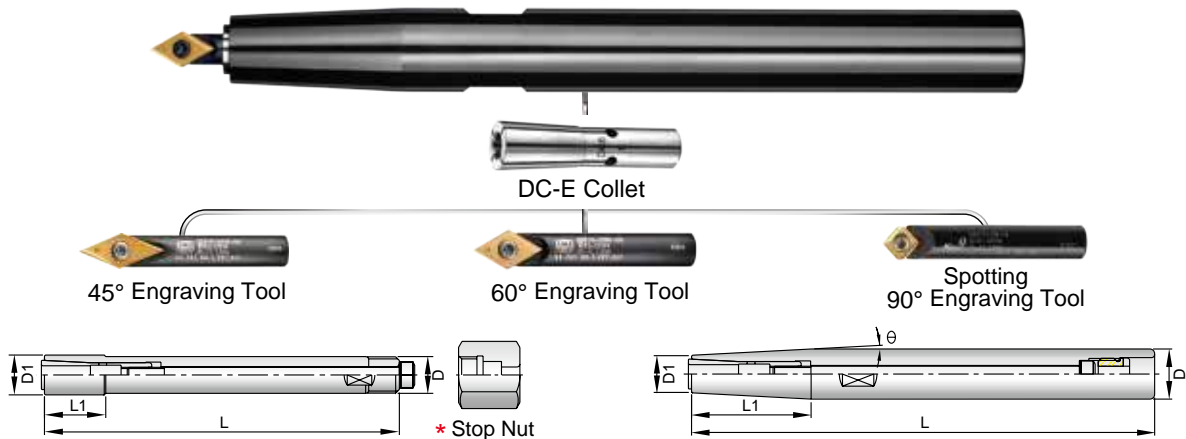

Parts No.	Type of Holder	d	L	L1	øD	D1	θ	Collet	Back Screw	Stop Screw	Hexagon Key	Stop Nut
0-329090-102	ST12-DC4-90	2~4	90	14	12	9	--	DC4	M4 * L60	--	0-301940~632	TP-M8
-112	ST12-DC4-120	2~4	120	38	12	9	3°		M4 * L85	OP-M8		--
0-329090-212	ST12-DC6-120	2~6	120	40	12	14	--	DC6	M5 * L95	--		TP-M12
-222	ST16-DC6-150	2~6	150	38	16	14	3°		M5 * L100	OP-M10	0-301940~642	--
-232	ST20-DC6-200	2~6	200	70	20	14	3°		M5 * L100	OP-M10		--
-242	ST25-DC6-250	2~6	250	115	25	14	3°		M5 * L100	OP-M10	0-301940~643	--
0-329090-322	ST20-DC8-200	3~8	200	28	20	19	2°	DC8	M6 * L120	OP-M12	0-301940~652	--
0-329090-432	ST25-DC10-250	4~10	250	28	25	24	2°	DC10	M8 * L150	OP-M16	0-301940~662	--

* Stop nut is applied when clamping and unclamping tools.

► DC-E Collet >>

- The design of DC-E collets is emphasized on increasing the clamping force of end mills.

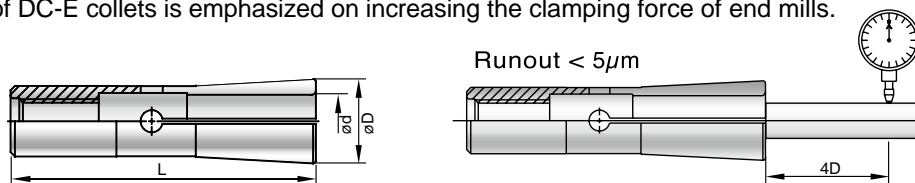

Type	DC-4E	DC-6E	DC-8E	DC-10E
D	7	9.6	15	19.1
L	31	36	45	52

DC4-E		DC6-E		DC8-E		DC10-E	
Parts No.	Size(mm)	Parts No.	Size(mm)	Parts No.	Size(mm)	Parts No.	Size(mm)
0-300090-102	2.0	0-300090-203	3.0	0-300090-303	3.0	-	-
0-300090-103	3.0	0-300090-204	4.0	0-300090-304	4.0	0-300090-404	4.0
0-300090-104	4.0	0-300090-206	6.0	0-300090-306	6.0	0-300090-406	6.0
				0-300090-308	8.0	0-300090-408	8.0
						0-300090-410	10.0

Extension Bar For NC Spot-Drill

► Solid Carbide Extension Ba >>

- TiN coated to identify the efficient length.



- NC Spot Drill
99616-10-M6 (P.19)
99616-14-M8 (P.21)



Order No.	Part No.	øD	T	L	M
00-99801-12W	BC12-100M06W	12	60	100	M6xP1.0
00-99801-14W	BC14-120M08W	14	70	120	M8xP1.25
00-99801-16W	BC16-150M08W	16	80	150	M8xP1.25

ISO 20/25 Tool Holder for Engraving Machine

► Tool Holder >>

- Runout: 0.01mm (4xD).
- Max. speed: 50,000 r.p.m.
- Applied with pull stud and nut.

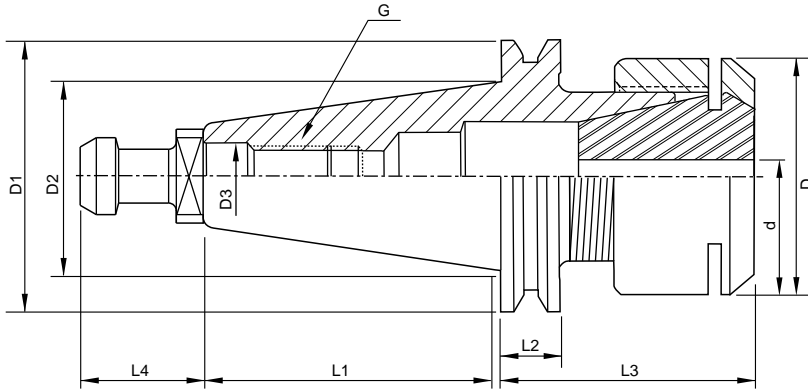

Taper Shank	Parts No.	Type	D1	D2	D3	D	L1	L2	L3	L4	G	Collet	Pull Stud	Clamping Nut
ISO20	225100-325	ISO20 ER16-R	33	22.2	8.5	22	33	8	30	12	M8	ER16	ISO20-D	CN-ER16R
ISO25	235100-425	ISO25 ER20-R	37	25.4	9	30	39.7	8	33	16	M8	ER20	ISO25-L	CN-ER20R

► Pull Stud >>

Parts No.	Type	L	L1	L2	D	D1	D2	D3	θ	G	SW
220000-150	ISO20-D	26	12	9	12	9	6	8.5	15°	M8	10
220000-250	ISO20-L	28	14	10	11	8.5	6	8.5	15°	M8	9
230000-150	ISO25-D	28	12	9	13	11	7	9	15°	M8	11
230000-250	ISO25-L	32	16	11.5	12	10	7	9	15°	M8	10

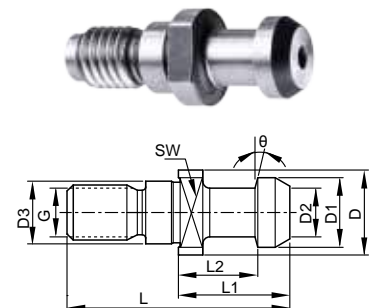

► Clamping Nut >>

Parts No.	Type	D	H	G
205100-302	CN-ER16R	22	19	M19X1.0P
205200-402	CN-ER20R	30	25	M25X1.5P

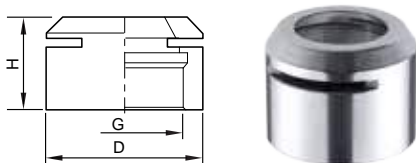

► Spring Collet >>

- Concentricity (0.01mm)

Parts No: 300100-3XX		Parts No: 300100-4XX	
Size	Range	Size	Range
ER16-3*	3-2	ER20-3	3-2
ER16-4	4-3	ER20-4	4-3
ER16-5	5-4	ER20-5	5-4
ER16-6	6-5	ER20-6	6-5
ER16-7	7-6	ER20-7	7-6
ER16-8	8-7	ER20-8	8-7
ER16-9	9-8	ER20-9	9-8
ER16-10	10-9	ER20-10*	10-9
		ER20-11	11-10
		ER20-12	12-11
		ER20-13	13-12

* Ordering example
ER16-3:300100-303-AA

* Ordering example
ER20-10:300100-410-AA

Center Height Adjusting Sleeve

▶ Principle >>

- Designed for adjusting Center Height of center drills, NC spot drills, reamers and taps on the CNC lathes.
- The main body is made from two sleeves. The inner sleeve is to hold and lock the cutting tool.
- Its center is inclined to the outer sleeve. When the inner sleeve is pushed or pulled, the cutting tool's center height is adjusted to lower or higher position.

▶ Parts No.:00-99600-320H >>

▶ Type : SB32-IDER20

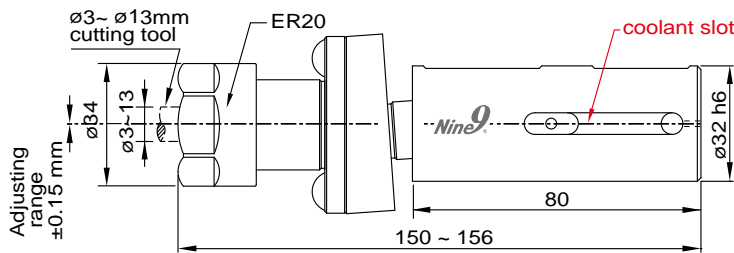

▶ Parts No.:00-99600-400H >>

▶ Type : SB32-ID16

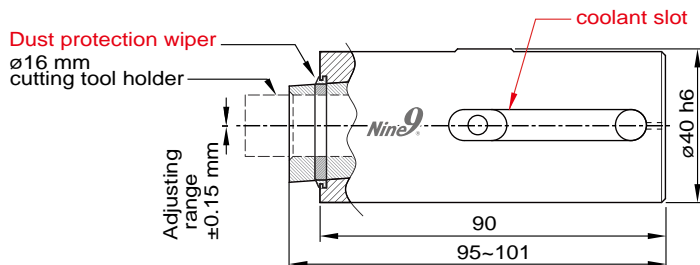

▶ Applications >>

- Used when the CNC lathes need to adjust the center height.
- This sleeve can be clamped by VDI 40, VDI 50 E2 tool holders, and other type of internal turning tool holders.
- Center height adjusting range: $\pm 0.15\text{ mm}$ (.006").
- Total axial movement is 6mm (.236").

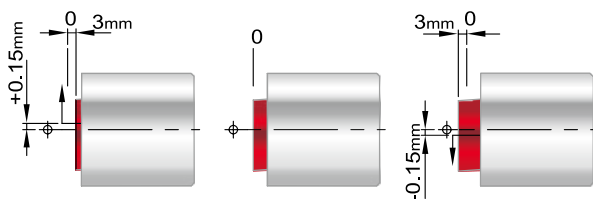

Tightening screw 4mm Hex key

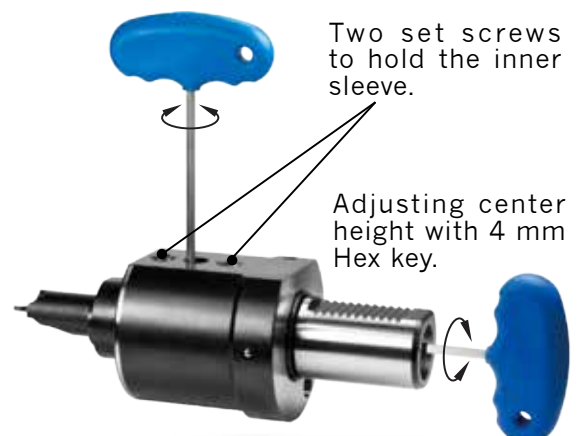

Center Height Adjusting Sleeve

▶ Principle >>

- Designed for adjusting Center Height of center drills, NC spot drills, reamers and taps on the CNC lathes.
- The main body is made from two sleeves. The inner sleeve is to hold and lock the cutting tool.
- Its center is inclined to the outer sleeve. When the inner sleeve is pushed or pulled, the cutting tool's center height is adjusted to lower or higher position.

▶ Parts No.:00-99600-320H >>

▶ Type : SB32-IDER20

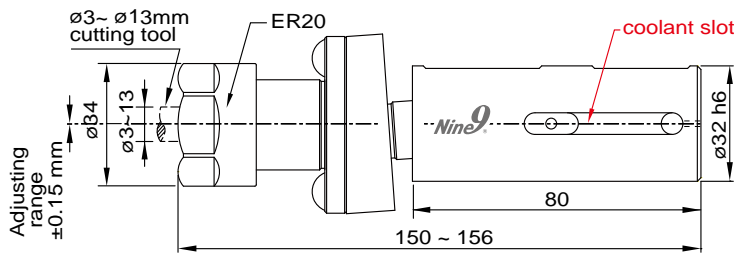

▶ Parts No.:00-99600-400H >>

▶ Type : SB32-ID16

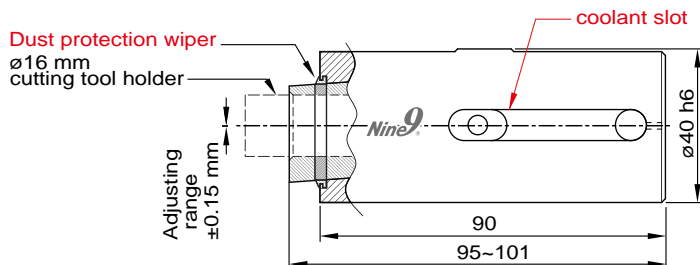

▶ Applications >>

- Used when the CNC lathes need to adjust the center height.
- This sleeve can be clamped by VDI 40, VDI 50 E2 tool holders, and other type of internal turning tool holders.
- Center height adjusting range: $\pm 0.15\text{ mm}$ (.006").
- Total axial movement is 6mm (.236").

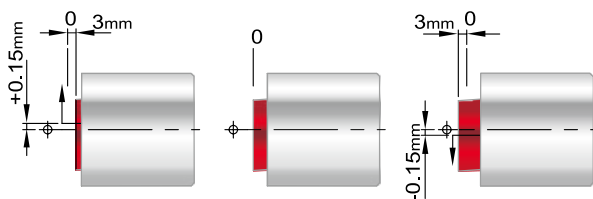

Tightening screw 4mm Hex key

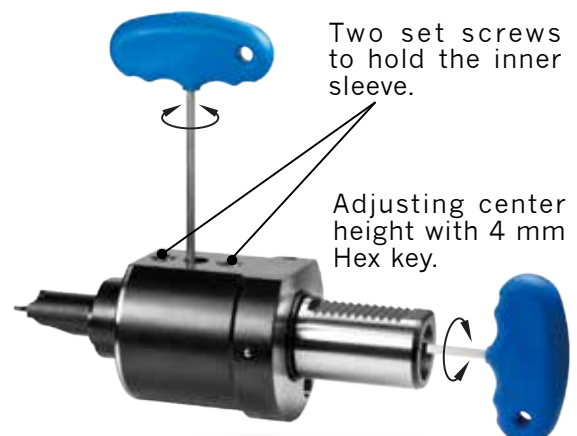

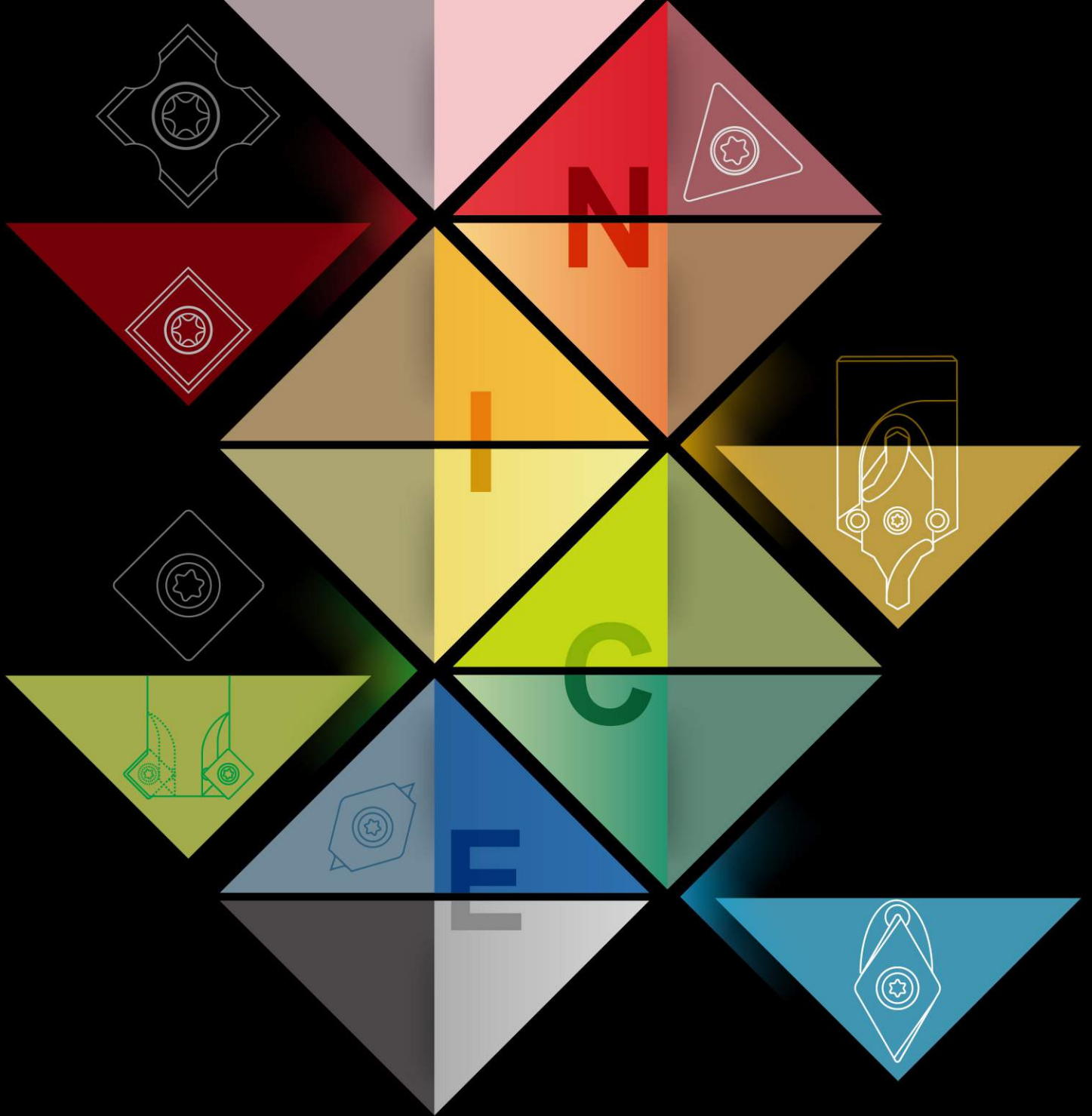

 **JIMMORE** International Corp.



Distributor